

Operating instructions

M-iClean U

Glass, dish and utensil washing machine



EN

Type: **US**
UM
UM+
UL



Read operating instructions before using the machine!

Contents

1	NOTES ON THE OPERATING INSTRUCTIONS	4
1.1	Product identification	4
1.2	Delivery contents	5
1.3	Related documents	5
2	LIABILITY AND WARRANTY.....	5
3	SAFETY	6
3.1	Symbol explanation	6
3.1.1	<i>Notes in the instructions</i>	6
3.1.2	<i>Safety symbols in the instructions</i>	7
3.2	Safety instructions on the machine	8
3.3	Requirements for the personnel	8
3.4	Residual risks	9
3.5	Intended use	10
3.6	Foreseeable misuse	11
3.7	Fundamental safety and accident prevention regulations	11
3.8	What to do in the event of an emergency	13
4	PRODUCT DESCRIPTION	13
4.1	Functional description	13
4.2	Overview illustration	14
4.3	Type label	15
4.4	LED indicator handle	15
4.5	Blue operating concept	15
4.6	Detergent and rinse aid	16
4.6.1	<i>Detergent</i>	16
4.6.2	<i>Rinse aid</i>	16
4.6.3	<i>Dosing equipment</i>	16
4.6.4	<i>Suction lances</i>	17
4.6.5	<i>Change of products</i>	17
4.7	Options	17
4.7.1	<i>GiO-MODULE</i>	17
4.7.2	<i>ComfortAir heat recovery</i>	17
4.7.3	<i>Bottle rack for M-iClean UM/UM+</i>	18
4.7.4	<i>Cold water final rinse for glasswashers</i>	18
4.7.5	<i>Disinfection control</i>	19
4.8	Automatic standard functions	20
4.8.1	<i>Eco mode</i>	20
4.8.2	<i>Forced drainage</i>	20
5	TECHNICAL DATA.....	20
5.1	Recess dimensions	21
5.2	EC/EU declaration of conformity	22
6	ASSEMBLY	22
6.1	Prerequisites for assembly	23
6.1.1	<i>Checking the condition at delivery</i>	23
6.1.2	<i>Requirements for the installation area</i>	23
6.1.3	<i>Requirements for the waste water connection</i>	23

6.1.4	<i>Requirements for the fresh water connection</i>	23
6.1.5	<i>Requirements to the electrical connection</i>	25
6.2	Transport	26
6.3	Perform assembly	26
7	COMMISSIONING	27
7.1	Check prerequisites for commissioning	27
7.2	Perform commissioning	27
8	OPERATION/USE.....	28
8.1	Glass control panel	28
8.2	Prepare dishwasher	29
8.2.1	<i>Putting the machine into operation</i>	30
8.3	Washing	31
8.3.1	<i>Putting away washware</i>	31
8.3.2	<i>Select wash programme</i>	31
8.3.3	<i>Start wash cycle</i>	36
8.3.4	<i>Emptying the washware</i>	37
8.4	Fill consumables	38
8.4.1	<i>Refill of internal storage container</i>	38
8.4.2	<i>Replace canister</i>	39
8.5	Malfunctions	39
8.5.1	<i>Messages</i>	40
8.6	Shutting down the dishwasher	42
8.7	Change authorisation level	43
8.8	Ventilating the pipes	45
8.9	Perform a manual water change	46
8.10	Reset the counter	46
8.11	Adjust dosing quantity	47
8.12	Activate/deactivate Bluetooth interface	47
8.13	Private Label 2.0	48
8.13.1	<i>Setting waiting time for Private Label</i>	50
8.14	Setting the waiting time for dimming the display brightness	50
9	MAINTENANCE AND CLEANING	50
9.1	Maintenance	51
9.2	Maintenance table	52
9.3	Daily cleaning	54
9.4	Cleaning the stainless steel surfaces	55
9.5	De-scaling	56
9.6	Spare parts	56
10	DISMANTLING AND DISPOSAL	57
10.1	Disposal of packaging materials	57
10.2	Dismantling and disposal of the old device	57
11	ABBREVIATIONS.....	57
12	INDEX	58
13	NOTES.....	60

1 Notes on the operating instructions

Dear customer,

We are delighted about the confidence you have shown in our products.

It is very important to us that you should enjoy using and benefit from MEIKO products and that they should make your work easier.

The operating instructions help familiarise the operator of this dishwashing machine with its installation, modes of operation, use, safety instructions and servicing.

The operating instructions are an integral part of the dishwashing machine and must be passed on to all subsequent owners or users.

Please read these operating instructions through carefully before use. Please also take note of any additional operating instructions for accessories and integrated third party components.

Only through understanding these operating instructions can errors be avoided and trouble-free operation of the dishwasher guaranteed. By paying attention to the operating instructions, hazards can be avoided, repair and breakdown costs reduced and the reliability and durability of the dishwashing machine can be increased.

Retain these operating instructions for the entire lifetime of the dishwashing machine. The storage location must be protected against moisture. Please store the operating instructions in a readily accessible location close to the dishwashing machine.

Ensure that all persons who work with or on the dishwashing machine have read and understood the operating instructions.

The operating instructions must be available in the local language for each EU country. If this is not the case, the washing machine must not be commissioned.

The original operating instructions in German and all operating instructions in all languages for EU countries can be downloaded from the following address: <https://partner-net.meiko-global.com>

The entire technical documentation are available free of charge. Additional copies are available for a nominal fee.

Notes on use of the operating instructions:

- A bullet point (•) designates an action step.
- Numerals (1.) designate several action steps that must be executed in the specified sequence.
- Position numbers in the text that refer to position numbers in figures are shown in parentheses:
(1) Position number 1 in the illustration
- The text is always below the figure and refers to it until a new image follows.

1.1 Product identification

These operating instructions apply to the following machine types:
glass, dish and utensil washing machine

M-iClean U Type M2

Name	M	i	Clean	U
Meaning	MEIKO	Intelligent	Clean	Undercounter

1.2 Delivery contents

The delivery contents include:

- 1x M-iClean U glass, dish and utensil washing machine
- Matching racks for glassware, dishes and containers depending on machine model
- Measuring cup for adding detergent and rinse aid for machines with internal dosing systems
- Key to change pre-filter (only with GiO option)
- Connecting hoses for fresh water and waste water
- Documentation

1.3 Related documents

In addition to these operating instructions, there are other documents that are available depending on the authorisation:

Operator (included in delivery contents)	Authorised service technician
EC/EU declaration of conformity	Dimension sheet
Short operating instructions	Installation instructions
Wiring diagram	Installation instructions for optional components (e.g. GiO module separately)
	Service instructions

2 Liability and warranty

All of MEIKO's obligations arise from the relevant purchase contract, which also contains the entire and only valid guarantee provisions. These contractual guarantee provisions shall be neither extended nor restricted as a result of any explanations given in the instructions.

If you follow the instructions in this operating manual carefully, your dishwashing machine will always give you total satisfaction and will have a long service life.

The delivered system corresponds to the state of technology and safety regulations valid at the time of production/delivery.

The information, data and notes specified in the operating instructions correspond to the latest version at the time of printing. No claims for already delivered systems may be asserted based on these statements, illustrations and descriptions.

Claims must be reported to the manufacturer immediately after determination of the defect or error. Liability claims for personal injury or material damage as well as for operational problems are excluded if they are due to one or more of the following causes:

- Unintended use.
- Improper installation, commissioning, operation and maintenance.
- Operation of the machine or system with defective safety devices or improperly attached or non-functioning safety and protective devices.
- Noncompliance with the notes in the operating instructions regarding transport, storage, mounting, commissioning, operation and maintenance.
- Unauthorised design changes or settings on the machine or system beyond the intended purpose.
- Improper monitoring of parts subject to wear.
- Use of wear and replacement parts that are not from the manufacturer.
- Improperly performed repairs, inspections or maintenance.
- Catastrophes due to human-induced events or force majeure.

3 Safety

3.1 Symbol explanation

3.1.1 Notes in the instructions

Warnings

Danger

Short description of the danger:

The signal word **DANGER** designates an immediately threatening danger.
Failure to observe this leads to very serious injuries or death

Warning

Short description of the danger:

The signal word **WARNING** designates a possible danger.
Failure to observe this can lead to very serious injuries or death.

Beware

Short description of the danger:

The signal word **BEWARE** designates a possible danger.
Failure to observe this can lead to minor to medium injuries.

Application information

Caution

Short description:

The signal word **Caution** designates a possible danger.
Failure to observe this can lead to damage to the machine or system.



Note

The signal word **Note** designates further information on the machine / system or its application.

3.1.2 Safety symbols in the instructions

The following note and danger symbols are used both in the document and on the machine. Observe these symbols and signs on the machine to avoid personal injury and material damage!

The symbols have the following meanings:

Symbol	Meaning
	Warning of hazardous areas
	Warning of dangerous electric voltage
	Warning of the danger of hand injuries Caution, keep hands away from parts that bear this warning symbol. The danger exists that hands can be crushed, pulled in or otherwise injured.
	Warning of hot surfaces and liquids
	Warning of the machine falling over
	Warning of environmental damage
	Do not spray with water
	No drinking water
	Access prohibited for persons with pacemakers
	Eye protection must be used or protective glasses must be worn
	Hand protection must be worn
	Read the operating instructions
	Disconnect before servicing or repair
	Potential equalisation connection

3.2 Safety instructions on the machine

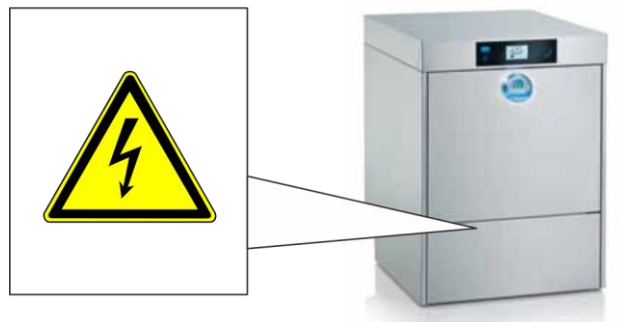

The machine has a safety note attached. This is located underneath the front panel.

3.3 Requirements for the personnel

Commissioning, instructions, repairs, maintenance, assembly and installation of or on MEIKO machines must only be carried out/authorised by MEIKO-authorized service partners.

During operation it must be ensured that:

- Only adequately trained and instructed personnel are allowed to work on the machine.
- Personnel responsibilities for operation, maintenance and repairs must be clearly defined.
- Any personnel undergoing training are only allowed to work on the machine under the supervision of an experienced person.

The required qualifications for performing specific work at the machine are determined by MEIKO.

Activity	Persons	Trained operating staff	MEIKO authorised company tradesman	MEIKO authorised service technician
Installation/assembly				✓
Commissioning				✓
Operation, use		✓	✓	✓
Cleaning		✓	✓	✓
Check safety devices			✓	✓
Troubleshooting		✓	✓	✓
Troubleshooting, mechanical		✓	✓	✓
Troubleshooting, electrical			✓*	✓
Maintenance			✓	✓
Repairs			✓	✓

* with training as an electrician



Note

The instructions must be acknowledged in writing.

Qualified staff, as defined by the operating Instructions, are persons:

- over 14 years of age,
- due to their training, experience and instruction are able to perform the required activities,

- are authorised to perform the required activities by the person responsible for safety of the machine,
- who have been trained in first aid and in the on-site rescue arrangements,
- have read and understood the operating instructions and corresponding safety instructions and will follow them.

3.4 Residual risks

Phase	Activity	Nature of the hazard	Avoidance measure
Transport and assembly	Loading and unloading with forklift truck	Crushing/impact	<ul style="list-style-type: none"> • Load-bearing capacity of the forklift truck must be adequate for the weight of the machine • Please note the machine's centre of gravity • Secure to prevent slipping
	Deposit at the installation location	Crushing/impact	<ul style="list-style-type: none"> • Ensure that the ground beneath is capable of taking the load • Ensure that the machine cannot tip
	Install electrical connections	Electric shock	<ul style="list-style-type: none"> • Only skilled personnel may connect up the machine • Adhere to the accident prevention regulations
	Install separate GiO MODULE (optional)	Trips/falls/crushing	<ul style="list-style-type: none"> • We recommend fastening the GiO MODULE to the wall/table/machine • Mount freestanding module using solid base • If necessary, run module at 90 degrees (lying)
Commissioning	Fill with detergent/rinse aid	Eye injury/health risks	<ul style="list-style-type: none"> • Wear safety eyewear/gloves • Avoid contact with skin and eyes
	Activities in the machine	Hand injuries on sharp edges	<ul style="list-style-type: none"> • Wear protective gloves
Operation	Programme is running	Scalding on inappropriate opening of door	<ul style="list-style-type: none"> • Do not open door during programme run
		Machine catching fire due to overload or blockage of pump motors	<ul style="list-style-type: none"> • Always use fine/coarse sieve when running the machine to keep out foreign bodies • Pre-wash washware
	Loading and unloading the machine	Trapping of hand	<ul style="list-style-type: none"> • To close the machine door, use the handle designated for this purpose
		Grazing finger on fan wheel if still running (unloading)	<ul style="list-style-type: none"> • Do not reach into fan wheel (positioned to rear of tank top)
		Broken crockery causing cuts/severing	<ul style="list-style-type: none"> • Wash washware in the specially designed rack in the machine • Place small items in the appropriate rack inserts • Washware must not come into contact with rotating parts of the machine
		Risk of snagging with loose clothing or items of jewellery	<ul style="list-style-type: none"> • Wear suitable work clothing and sturdy shoes • Do not wear rings, necklaces or other pieces of jewellery
		Slipping	<ul style="list-style-type: none"> • Use non-slip floor coverings
		Scalding	<ul style="list-style-type: none"> • If necessary, allow washware to cool down • If necessary, allow machine components to cool down before touching • Do not remove tank cover sieve while machine is in operation • Protective gloves recommended
	Other activities	Injury through standing or sitting on the open machine door	<ul style="list-style-type: none"> • Ensure that nobody sits or stands on the door
		Swallowing of water in the wash chamber	<ul style="list-style-type: none"> • Do not use the water in the wash chamber for food preparation or drink it

Phase	Activity	Nature of the hazard	Avoidance measure
	Independent changes to chemical dosing	Breathing difficulties/suffocation	<ul style="list-style-type: none"> Only allow specialist personnel to adjust dosing
	Refilling detergent/rinse aid	Tripping/falling over open dosing cover	<ul style="list-style-type: none"> Close dosing cover as soon as refilling is complete
		Eye injury/health risks	<ul style="list-style-type: none"> Wear safety eyewear/gloves Avoid contact with skin and eyes
Maintenance and cleaning	Any maintenance work	Electric shock	<ul style="list-style-type: none"> Before opening the housing parts, ensure the mains switch has been disconnected and secured so that it cannot be turned on again Only specialist personnel may carry out maintenance work
	Cleaning or maintenance	Tripping/falling over open door	<ul style="list-style-type: none"> Always close door after use
		Scalding/burning	<ul style="list-style-type: none"> Allow machine components to cool down before touching Wear protective gloves
		Hand injuries on sharp edges	<ul style="list-style-type: none"> Wear protective gloves
	Cleaning	Poisoning	<ul style="list-style-type: none"> Do not use aggressive cleaning or scouring agents Only use descaling products suitable for commercial machines Wear protective gloves
GiO MODULE: replace filter cartridge	Water escaping	<ul style="list-style-type: none"> Provide suitable vessel (e.g. base drip tray) 	
Dismantling and disposal	Dismantling	Eye injury/health risks	<ul style="list-style-type: none"> Wear safety eyewear/gloves Avoid contact with skin and eyes If necessary, clean hoses, dosing system and machine parts with fresh water
	Loading and unloading with forklift truck	Crushing/impact	<ul style="list-style-type: none"> Load-bearing capacity of the forklift truck must be adequate for the weight of the machine Please note the machine's centre of gravity Secure to prevent slipping

3.5 Intended use

The dishwashing machine must only be used in accordance with its intended purpose and as per these operating instructions. The dishwashing machine is intended exclusively for commercial use.

The dishwashing machine is designed for cleaning dishes, cutlery, glassware, kitchen utensils, baking trays and containers.

The washware must be suitable for dishwashing machines. If there is any doubt, a consultation (size, version, basic suitability for dishwashing machine, etc) can be carried out with MEIKO to confirm suitability (info@meiko-global.com).

The following applications are expressly not intended:

- Processing hazardous substances in the machine (health hazards, in particular toxic, highly or extremely flammable and explosive substances).
- Operating the machine in an explosive environment.

3.6 Foreseeable misuse

The dishwashing machine must not be used for:

- Washing kitchen utensils with electronic components
- Cleaning textiles, oven cloths or steel sponges
- Washing utensils made of iron or utensils that must not come into contact with foodstuffs (e.g. ashtrays, candlesticks, etc)
- Cleaning living creatures
- Washing food for subsequent consumption
- Preparing foodstuffs in the machine
- Taking wash fluid to prepare food or for drinking
- Washing support grids of cooking hobs / gas hobs
- Filling the machine from an external source (e.g. shower)
- Introducing service water into the local waste water system
- Standing or sitting on machine parts (e.g.: door)
- Washing parts made of wood
- Washing plastic parts that are not heat and alkali-stable
- Washing parts made of aluminium (such as pots, containers or trays only with a suitable detergent to avoid black discolouration)

3.7 Fundamental safety and accident prevention regulations



Note

The following safety instructions aim to protect operating personnel as well as third parties and the dishwashing machine itself.

Please take note of the information in these instructions and the signs on the dishwashing machine.

However, safety can only be guaranteed during operation if all necessary measures are taken.

The operator of the machine has an obligation of care to ensure that these measures are planned for and also to check that they are correctly implemented.

The operator must ensure in particular that:

- The dishwashing machine is only used in accordance with its intended purpose. In the event of the machine being used or operated contrary to this, damage or risks may arise.
- In order to guarantee functionality and safety, only original spare parts supplied by the manufacturer may be used.
- The safety of the dishwashing machine is not impaired by the subsequent installation of a dosage system.
- Only appropriately qualified and authorised personnel operate, maintain and repair the dishwashing machine.
- No one sits or stands on the open door.
- Staff are regularly trained in all questions relating to occupational safety and environmental protection and are familiar with the operating instructions and, in particular, the safety information that they contain.
- The area around the machine is assessed with reference to the risk to other people, e.g. children; people with physical, sensory or mental impairments; people lacking in knowledge or experience. In case of doubt, special optional initiation functions other than conscious, intentional operation (i.e. operation from the screen) are to be deactivated.
- The dishwashing machine is only operated in perfect, functional condition, all protection devices and covers are installed.
- The safety and switching equipment is regularly tested to ensure it is functioning correctly.
- Dishwashers accessible from behind may only be operated with a rear cover.

- The required personal protective equipment is made available to and worn by maintenance and repair personnel.
- A functional test on all dishwashing machine safety systems is carried out at every regular maintenance appointment.
- None of the safety and warning notices affixed to the dishwashing machine itself are removed and all are legible.
- Upkeep (maintenance and inspection) is carried out on optional vendor parts according to the requirements in the corresponding instructions.
- Following installation, commissioning and handing over of the dishwashing machine to the customer/operator, no modifications are made (e.g. electrical or mechanical machine components).

Information on operating the dishwashing machine:

- Only operate the dishwashing machine under the supervision of trained personnel.
- Do not use the dishwashing machine if you are unsure about its operation.
- Always close all doors and flaps.
- Wear suitable work clothing.
- When working on the dishwashing machine, wear appropriate protective gloves.
- Allow machine components and washware to cool down before touching.
- At the end of operation:
 - Switch off the dishwashing machine at the on-site mains disconnection device. This is located in the electricity supply pipe for the machine.
 - Close the on-site stop valve in the fresh water supply line.

Information on use of detergent and rinse aid:

- Only use detergents and rinse aid suitable for commercial dishwashing machines.
- Acquire information from the manufacturers of these products.

Detergent and rinse aid may contain hazardous substances. The wash water used during operation contains chemicals.

- Never drink the wash water.
- Contact a doctor immediately if wash water is swallowed.
- Pay attention to the manufacturers' hazard warnings on the original canisters and safety data sheets.
- When handling chemicals, wear appropriate protective gloves and safety eye-wear.
- Do not confuse detergent and rinse aid.
- Ensure that the suction connections for the dishwashing machine are correctly connected to the canisters.
- An LED light source is used to illuminate the wash chamber and the door handle. Never look directly at the light source for more than 30 minutes a day.

Information on the use of descaling agents

Residue from descaling agents can cause damage to the plastic components and sealing materials in the machine.

- Acquire information from the manufacturers of these products.
- Please observe the manufacturer's hazard warnings.
- Thoroughly remove any residue after use.

Information on cleaning the machine

Foam can cause malfunctions in the dishwashing machine and a poor washing result.

- Do not use a foaming manual dishwashing detergent for precleaning or for cleaning the machine.
- Allow machine components and washware to cool down before touching.

Information on cleaning the surrounding area

When cleaning the surrounding area, the machine can be damaged by aggressive external influences (steams, detergents) or the ingress of water.

- Do not use aggressive detergents (e.g. aggressive tile cleaner).
- If installed at ground level, never allow the surrounding area to flood.

Notices on electrics and electronics

There is a danger to life if exposed parts and damaged supply lines under electrical voltage are touched.

- Please take note of the warning information in these instructions and the signs on the dishwashing machine.
- Whenever you are working on electrical components in the machine, ensure that electrical connections are physically secure.
- Whenever you are working on electrical components in the machine, check wires and cables for any potential damage and replace, if necessary.

Incorrect cleaning can cause damage to the electronics.

- The dishwashing machine, switch cabinets and other electrical components must never be sprayed with a hose or high pressure cleaner.
- Ensure that no water can enter the machine by accident.

Notice on non-ionising radiation



The dishwasher does not specifically generate non-ionising radiation. For technical reasons, only the electric appliances emit non-ionizing radiation.

In the immediate vicinity of the dishwashing machine, the influence of active implants (e.g. cardiac pacemakers, defibrillators) can be ruled out with a high degree of probability.

3.8 What to do in the event of an emergency



- In dangerous situations, disconnect from the power supply using the locally available mains isolator.

4 Product description

4.1 Functional description

The M-iClean U is a glass, dish and utensil washing machine with a square rack.

The dishwasher has one wash and one final rinse cycle.

A temperature regulator maintains the set wash temperature of between 58-60 °C. A rotary pump circulates the water from the wash tank into the wash nozzles. The water jets hit the wash ware from different directions. This ensures uniform washing results.

The wash cycle is followed by a fresh water final rinse. The items being washed are rinsed with hot fresh water at 80-83 °C (65 °C for the glass programme) via a separate nozzle system. This heats up the wash ware for the following drying process.

At the same time, the final rinse water is used to regenerate the rinse water; this reduces the degree of soiling of the rinse water.

4.2 Overview illustration



- | | |
|------------------------|--|
| 1 Operating display | 4 Front panel |
| 2 LED indicator handle | 5 Connectors for detergent and rinse aid |
| 3 Machine door | |

The dosing pumps for detergent and rinse aid are located under the front panel (4).

- To remove the front panel (4), push it gently upwards, tip and then pull it out of the slot.



The optional GiO module (1) is located in different positions depending on the particular model ordered.

- In the external casing next to the machine.
- Integrated beneath the machine.
- Integrated at the rear of the machine.

4.3 Type label

On the M-iClean U, the rating plate is located on the inside of the lower front panel.

 MEIKO Maschinenbau GmbH & Co. KG Englerstraße 3 D-77652 Offenburg		①
Glass – and dishwashing machine		②
Type:		③
SN:		④
Voltage:	3 N/PE 400 V 50 Hz	⑤
El.Total load:	6.7 kW 14.0 A	⑥
EL.connect Boiler:	6,0 kW	⑦
Water pressure:		⑧
Boiler capacity:	7,9 l	⑨
Steam:		⑩
Year of Constr.:	2017	⑪
 		⑫

The rating plate includes the following information:

- 1 Manufacturer name and address
- 2 Machine type
- 3 Model name
- 4 Serial number
- 5 Current type
- 6 Electrical connection
- 7 Rated power, boiler
- 8 Water pressure
- 9 Boiler capacity
- 10 Steam connection
- 11 Year of manufacture
- 12 CE mark
- 13 IP protection rating

4.4 LED indicator handle

 Blue Ready for operation	 Green Programme is running	 Red Malfunction / important message
---	---	--

4.5 Blue operating concept



- 1 Blue handle on tank cover sieve
- 2 Blue filter

The parts of the dishwasher that must be touched by the operator in operation and in daily use are blue. And so after a short briefing, operators know intuitively that they have to remove and clean the wash system, tank cover sieve and filter, for example.

4.6 Detergent and rinse aid



⚠ Warning

Risk of injury from contact with chemicals

- Observe the safety data sheets and dosing recommendations of the chemical manufacturers.
- Use eye protection.
- Wear protective gloves.
- Do not mix different chemical products.

⚠ Caution

- Only use products that are suitable and approved for commercial dishwashers. MEIKO recommends MEIKO ACTIVE detergent and rinse aid. MEIKO ACTIVE products are optimally adapted to MEIKO dishwashing machines.
- Do not mix different cleaning products.

The dishwashing machine is equipped by default with dosing units for dosing liquid detergent/rinse aid. Manual dosing with powder cleaner is not intended.

Optionally, the dishwashing machine can be equipped with or prepared for an external dosing system. In this case, further information can be found on the wiring diagram and in the External dosing document.

4.6.1 Detergent

Detergents are alkaline (pH value should be > 7) and are needed to dissolve soiling from the washware. The standard setting is 2 ml of detergent per litre of tank water. If necessary, the concentration can be adjusted depending on the water quality, washware and degree of soiling. This setting is made during commissioning by an service technician authorised by MEIKO or the chemical supplier.

Change dosing quantity, see page 47.

4.6.2 Rinse aid

Rinse aids are acidic (pH value should be between 2 and 7) and accelerate the drying of the washware by reducing the surface tension of the water so that it can run off the washware quickly.

The correct dosage is achieved when the water drips evenly from the washware and depends on the available water quality on-site. This setting is made during commissioning by an service technician authorised by MEIKO or the chemical supplier.

Change dosing quantity, see page 47.

4.6.3 Dosing equipment

The components of the dosing units are subject to high demands and must therefore be regularly maintained and, if necessary, replaced in accordance with the maintenance specification.

The service life of the dosing units and other components of the dishwashing machine depends on the use of suitable chemical products. MEIKO recommends MEIKO ACTIVE detergent and rinse aid. MEIKO ACTIVE products are optimally adapted to the dishwashing machine.

4.6.4 Suction lances

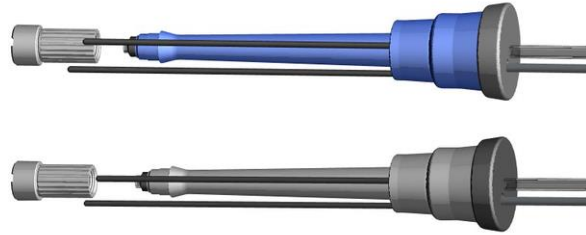

Suction lances with level monitoring for rinse aid (blue) and detergent (grey)

Suction lances ensure that the liquid chemical product is sucked in correctly. Suction lances are inserted vertically into the canisters and are optionally equipped with level monitoring. When the canister is running low, a message will appear on the machine display.

4.6.5 Change of products

⚠ Caution

When changing the detergent product (even to a product from the same manufacturer), crystallisation may occur, which can lead to failure of the dosing system.

- When changing the detergent product, flush the dosing system with warm water.

Procedure for changing the detergent product:

1. Provide a suitable container with warm water and insert the suction lance.
2. Thoroughly flush the dosing system several times by **venting the lines**, see page 45.
3. Wipe the suction lance and put it into the canister with the other detergent product.
4. Refill the dosing system by **venting the lines**.

For dishwashers with an internal reservoir, have the system flushed by a service technician authorised by MEIKO.

4.7 Options

4.7.1 GiO-MODULE

The module works according to the principle of reverse osmosis. Drinking water is pressed by a pump through a semi-permeable membrane. The membrane lets only water molecules through. The hardness components and salts (lime scale, etc.) contained in the water are held back. The clean water (permeate) is brought to the dishwashing machine; the materials held back (concentrate) are brought to the drain.

4.7.2 ComfortAir heat recovery



Two heat exchangers can be found in the side walls of the dishwashing machine. These are filled with cold fresh water after the final rinse. A fan inside the machine moves the air around so that the steam moves down and comes into contact with the side walls. The water is warmed and is fed into the boiler so it is available for the next wash cycle.

4.7.3 Bottle rack for M-iClean UM/UM+



Up to 16 bottles or carafes can be rinsed in the bottle rack at the same time. When washing bottles, the lower wash arm is replaced by an adapter.

4.7.4 Cold water final rinse for glasswashers



For glasswashers (available at M-iClean UM), final rinsing in programmes I and II is not carried out with hot (65°C) water, but with fresh water that is not heated.



Note

When the programme is changed from a hot final rinse programme to programme I or II, it takes approximately 3-4 programme runs for the final rinse programme to be performed with cold water.

When the programme is changed from programme I or II to a programme with hot final rinse, the required temperatures are reached in the same programme run.

 Programme I (short programme cold)	 Programme II (standard programme cold)
---	---

The glasses are cleaned with a rinsing temperature of 55°C. Then follows the final rinse with unheated fresh water.

The cooling of the glasses can lead to temperature stresses in the glasses, which require additional caution!

These glass temperatures can be assumed at a temperature of approx. 10°C for the incoming water:

- Approx. 22-27°C immediately after removal
- Approx. Room temperature, 1-2 minutes after removal
- Approx. 30-35°C for thick-walled glasses (beer mugs), immediately after removal

To ensure that the rinsing temperature of 55°C is reached, the machine has an extended running time. This means that the programme runs until the water is heated to the required temperature (however, for a maximum of 5 minutes).

 Programme III (Intensive hot programme)

The glasses are cleaned with a rinsing temperature of 60°C. The final rinse is then carried out with fresh water heated to 65°C. The described extension of the running time also ensures that the required temperatures are reached in Programme III.

4.7.5 Disinfection control

Caution

Glass corrosion and loss of decorations due to high water temperatures and long wash cycle times

- Make sure that the dishes and glassware used are suitable for the high stress placed on them.

MEIKO offers two types of machine with thermal disinfection for institutions with additional hygiene requirements. Both versions have greater heating performance in the wash tank than standard machines.

A₀ control

The term **A₀** refers to a way of measuring how microorganisms are eliminated by moist heat disinfection methods. By using a moist heat disinfection method, it is expected that a specific temperature over a period of time has the effect of eliminating a predictable number of microorganisms with a particular resistance.

The standard setting for a dishwasher with **A₀** – control is the hygiene value **A₀ 30**:

- The tank temperature during washing is up to 74° C.
- For tank temperatures of 65° C or higher, each tank temperature is assigned a factor.
- Using the measured tank temperature, a value is determined and added every second until the hygiene value **A₀ 30** is reached.
- The rinsing process runs until the end of the programme cycle time, but at least until the temperature value is reached. After this comes a pause for draining and the final rinse.

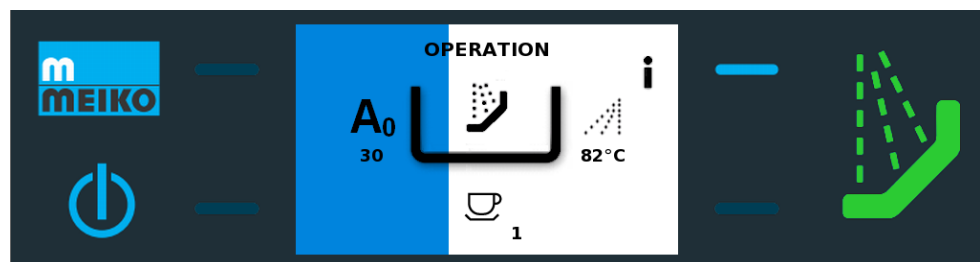

The display shows the current A₀ value.

Thermolabel control

In a way which is similar to A₀ control, machines with Thermolabel control have a disinfection process which uses moist heat. The dishwasher heats the rinse water to a higher temperature in order to eliminate germs. The efficacy of the disinfection can be tested using a measurement strip, the Thermolabel. The measurement strip changes colour after 4 seconds at 71 °C for a wash item.

- During washing, the tank temperature is heated up to 71° C and maintained at that temperature.
- The rinsing process runs until the end of the programme cycle time, but at least until the temperature value is reached. After this comes a pause for draining and the final rinse.
- Washing at high temperatures and long spells in the wash tank can lead to glass corrosion and premature wear to decoration.

Thermal disinfection - control

Thermal disinfection works according to the same principle as Thermolabel control, but other requirements apply:

- The disinfection temperature is $\geq 80^{\circ}$ C, which must be maintained on the washware for ≥ 30 s.
- During washing, the tank temperature is heated up to 76° C, and the final rinse temperature is 88 °C.

- The rinsing process runs until the end of the programme cycle time, but at least until the temperature value and specified stop time are reached. After this comes a pause for draining, final rinse and a subsequent application time.

Thermolabel and thermal disinfection control offer a disinfection effect that exceeds the standard, such as for hospitals, care homes, requirements according to the ÖGSV Guideline.

4.8 Automatic standard functions

4.8.1 Eco mode



During periods of inactivity (pauses), the machine displays a leaf symbol to show that energy is being saved and components protected.

	Active following	Description
ECO MODE I	60 sec	Rinse water temperature reduced.
ECO MODE II	180 min	Rinse and wash water temperatures reduced. Water level in wash tank adjusted to optimum level.
ECO MODE III	8 h	Boiler is drained. Wash water temperature is reduced. Water level in wash tank adjusted to optimum level.
ECO MODE IV	14 h	Machine is drained and shut down.

4.8.2 Forced drainage

If the wash tank and boiler have been full for 24 hours, they will be force drained. The water in the wash tank and boiler is pumped out.

Forced drainage takes place depending on operational status:

- **MACHINE OFF:** when machine is switched on
- **ECO MODE:** either after 24 hours or upon start of Eco mode III or IV, .
- As soon as the door or hood is closed for the first time after 24 hours have passed.

5 Technical data

MEIKO has created a dimensional drawing that shows machine dimensions as well as connection and consumption values.

Further data should be taken from the MEIKO dimensional drawing.

Machine weight

Equipment Versions	Basic machine	Basic machine + GiO in the base	Basic machine + GiO separate
M-iClean US	56 kg	63 kg	80 kg
M-iClean UM	63 kg	82 kg	87 kg
M-iClean UM+	74 kg	93 kg	98 kg
M-iClean UL	77 kg	96 kg	101 kg

Noise emissions

Work place noise level $L_{pA} \leq 70$ dB

Water pressure

The water pressure for the fresh water supply before the solenoid valve must be in the following pressure range:

- Machines without GiO module: 0.6 - 5 bar
- Machines with GiO module: 1 - 5 bar
- If the minimum pressure flow is too low, increase the pressure using a booster pump.
- If the maximum pressure is exceeded, limit the pressure using a pressure regulator.

5.1 Recess dimensions

When installing the dishwasher in a counter, recess dimensions must be observed. The dishwasher does not need to be fixed in the counter.

Furniture in the vicinity of the dishwasher must be suitable for commercial use and resistant to steam.

Dishwasher without plinth

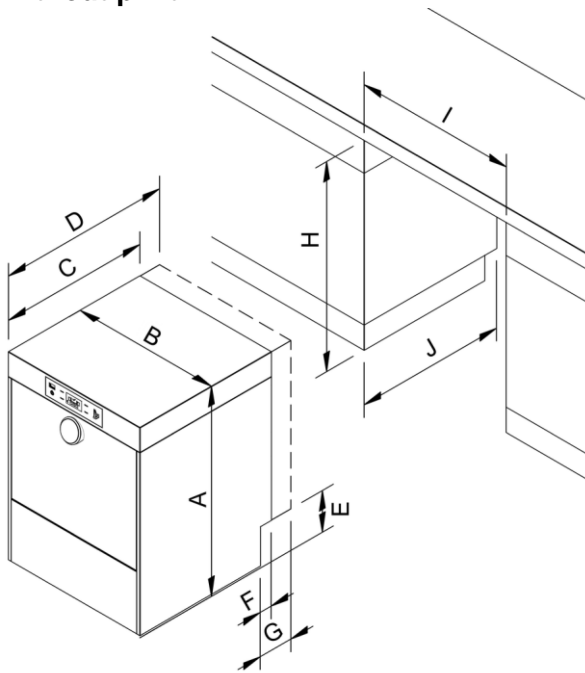

The dishwasher can also be set up without feet, in which case alignment is no longer possible.

Height of the machine without feet in mm:

US/ US GiO rear panel/ UM/ UM (GiO rear panel)	UM+/ UM+(GiO rear panel)/ UL
700 ⁺⁵	820 ⁺⁵

M-iClean U / M-iClean U Type M2 (dimensions in mm)							
	US	US (GiO rear panel)	UM	UM (GiO rear panel)	UM+	UM+ (GiO rear panel)	UL
A	710–735	710–735	710–735	710–735	830–855	830–855	830–855
B	460	460	600	600	600	600	600
C	600	–	600	–	600	–	680
D	–	690	–	690	–	690	–
E	155	155	155	155	155	155	155
F	50	–	50	–	50	–	130
G	–	140	–	140	–	140	–
H	715–735	715–735	715–735	715–735	835–855	835–855	835–855
I	470–480	470–480	610–620	610–620	610–620	610–620	610–620
J	605	695	605	695	605	695	685

Dishwasher with plinth 120 mm or 150 mm

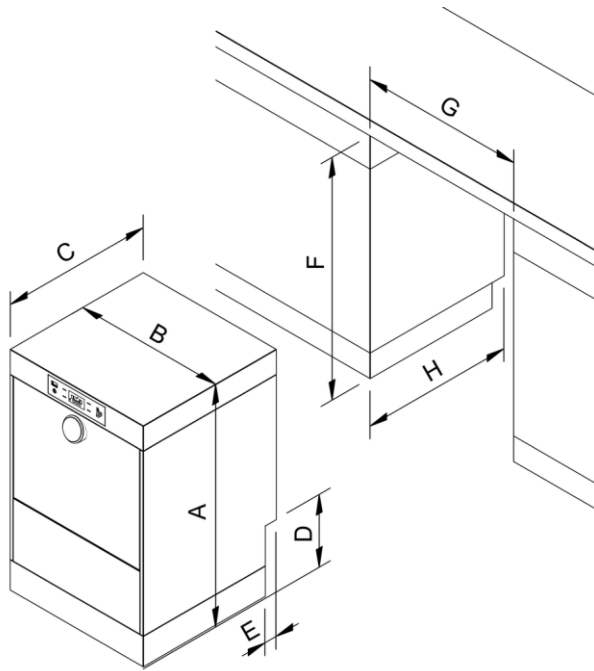

The dishwasher can also be set up without feet, in which case alignment is no longer possible.

Height of the machine without feet in mm:

US 120/ UM 120	US 150/ UM 150	UM+ 120/ UL 120	UM+ 150/ UL 150
820 ⁺⁵	850 ⁺⁵	940 ⁺⁵	970 ⁺⁵

M-iClean U / M-iClean U Type M2 (dimensions in mm)								
	US 120	US 150	UM 120	UM 150	UM+ 120	UM+ 150	UL 120	UL 150
A	830–855	860–885	830–855	860–885	950–975	980–1005	950–975	980–1005
B	460		600		600		600	
C	600		600		600		680	
D	275	305	275	305	275	305	275	305
E	50		50		50		130	
F	835–855	865–885	835–855	865–885	955–975	985–1005	955–975	985–1005
G	470–480		610–620		610–620		610–620	
H	605		605		605		685	

5.2 EC/EU declaration of conformity

See separate EC-/EU-Declaration of Conformity.

6 Assembly

Warning

Danger of injury from entering a danger zone

Unauthorised persons might be in or enter the danger zone during transport, assembly, commissioning, maintenance and repair work. This can lead to injuries.



- Only permit qualified persons to perform work at the machine.
- Remove unauthorised persons from the danger zone.
- Cordon off danger zone and signpost it for third parties.
- Never remove or disable safety devices on the machine.
- Always wear cut-resistant protective gloves when removing housing parts and when working inside the machine!

6.1 Prerequisites for assembly

6.1.1 Checking the condition at delivery

- Check that the delivery is complete immediately after receiving it by comparing it with MEIKO's order confirmation and/or the delivery note.
- If applicable, submit a claim for any missing parts immediately to the freight forwarder and notify MEIKO.
- Check the machine for transportation damage.



Note

If there is any suspicion of transportation damage, the shipping company and MEIKO must be informed immediately in writing. Photograph any damaged parts and send the pictures to MEIKO.

6.1.2 Requirements for the installation area

The dishwashing machine is only frost-proof in as-delivered state or if equipped with special features (optional: frost removal).

Installation of the dishwashing machine in an area where the ambient temperature is below 0° C can result in damage to the internal water circuit components (e.g. pump, solenoid valve, boiler, etc.).

- Ensure that the storage and installation locations are always frost free.

There is a danger of slipping in the working area due to the use of water.

- After assembly, put in place non-slip floor coverings in the working area based on the general/location-specific safety regulations.

6.1.3 Requirements for the waste water connection

A waste water pump is integrated into the drain pump.

- Connect the drainage hose to the locally available waste water pipe.

– For Australia only:

The drainage hose needs to have a watertight connection to a waste fitting complying with AS 1589 AS 2887, a sanitary plumbing pipe or fitting complying with AS/NZS 1260.

- Depending on the dishwasher application, a grease trap may be included, based on the general/location-specific regulations.
- For dishwashers with GiO MODULE, the maximum drain height must be considered (see dimensional drawing).

6.1.4 Requirements for the fresh water connection

For Australia only:

All work carried out must be in accordance with AS/NZS 3500.1!

Fresh water connections and their components must be carried out in accordance with local regulations, e.g. EN 1717/DIN 1988-100. The fresh water must be of the same quality as drinking water in microbiological terms. This also applies to processed water.

The basic model of the dishwashing machine features an air gap (type AA or AB as per EN 1717 or EN 61770). In the case of SVGW (Switzerland) and other countries, a type EA safety device is also required in front of the connecting hose, depending on the machine version. Installation components and materials must be suitable and permitted in accordance with local regulations. A solenoid valve is integrated into the dishwashing machine's fresh water line. This, together with the leakage detector in the floor tray in the frame, ensures that the fresh water inlet within the machine is shut off in the event of a leak.

Pressure range of the fresh water supply flow pressure upstream of the solenoid valve:

- Machines with no GiO MODULE:
0.6 – 5 bar (60–500 kPa)
- Machines with GiO MODULE or ActiveClean water softener:
1 – 5 bar (100 – 500 kPa)

Maximum pressure

- The maximum pressure of 5 bar (500 kPa) must not be exceeded.

Measures to ensure correct water pressure:

- If the minimum flow pressure is too low, increase the pressure using a pressure booster pump.
- If the maximum pressure is exceeded, limit the pressure using a pressure regulator.

Other measures:

- Ensure that no rogue iron particles can enter the appliance via the mains fresh water connection. The same also applies for contamination by other metal particles (e.g. copper shavings). Corresponding instructions are contained in the installation drawing.
- A dirt trap must be fitted in the fresh water supply to protect the solenoid valve.
- After the dishwashing machine has been unused for an extended period of time, drain the connection line and rinse it before putting the machine back into operation.
- When replacing an old machine with a new one, make sure that the existing feed hose is exchanged for the new feed hose supplied with the machine.

Table: fresh water requirements for the operation of a reverse osmosis module

Designation	Value
Conductivity	70–1000 µS/cm
Water hardness	0–28 °dH
Feed water temperature	Min. 1 °C to max. 35 °C (cold water connection)
Minimum flow pressure	100 kPa (1 bar)
Maximum pressure	500 kPa (5 bar)
Free from particles	> 10 µm
Iron	< 0.1 mg/l
Manganese	< 0.04 mg/l
Chlorine (free chlorine)	< 0.1 mg/l (standard membrane)
Chlorine (free chlorine)	≥ 0.1 to ≤ 2.0 mg/l (more chlorine resistant membrane)
Potassium permanganate	< 10 mg/l
Silicic acid	< 10 mg/l

6.1.5 Requirements to the electrical connection



Warning

Danger to life from electric shock

Contact with live electrical parts can lead to serious injury or death.

- Work at or repairs to the electrical system must be conducted by a qualified electrician who complies with the electrotechnical rules.
- Disconnect the machine from the power supply before working on the electrical system. To do this, turn the local mains switch to **OFF** and ensure that it can't be switched back on again.

Note

The wiring diagram is located behind the front panel of the dishwashing machine. This must remain in the machine!

The type plate with the electrical connected values is located inside the front panel.

To ensure that the appliance can be connected, the following has to be provided by the customer:

The correct voltage and type of current must be available.

The power supply must be safeguarded in accordance with the regulations and a main switch provided in the fixed electrical installation.

If an unearthed neutral conductor (N) is used with three-phase current, the power disconnection device must have 4 poles (with alternating current 2 poles).

The dishwashing machine must be connected to a potential equalisation system!

If the neutral line (N) is not earthed, you must use a 4-pin mains switch. Mains power cables must be oil-resistant, shielded cables no lighter than an H07RN-F cable.

A 5-pole terminal strip (L1, L2, L3, N, PE) must be used for connection to a three-phase current.

Electricity supply without a neutral conductor (N): when connecting to three-phase current, use a 4-pole clamping strip (L1, L2, L3, PE).

Conductor colours: live conductor L1 = black/1, L2 = brown/2, L3 = grey/3, neutral conductor N = blue/4, ground wire conductor PE = green-yellow

The potential equalisation connection must be carried out in accordance with the requirements of the local electricity supply companies and all applicable local regulations (in Germany VDE 0100 Part 540 must be observed).

The products are intended for permanent connection to the locally available power supply and have been tested for the market accordingly. Any other form of electrical connection is to be established by a licensed electrician.

Do not connect any additional consumers to the fuse protecting the machine.

- Re-tighten all terminal fixing screws before commissioning.

Note for frequency converter

If using a frequency converter within the area for the VDE 0160 / EN 50178, an all-current sensitive FI type B must be installed before or instead of the existing fault current circuit breaker FI type A.

For USA/Canada only:

The dishwashing machine must be installed in accordance with local regulations. In the absence of any such regulations, the machine must be installed in accordance with the applicable requirements in the National Electrical Code, NFPA 70, Canadian Electrical Code (CEC), Part 1, CSA C22.1 and the Standard for Ventilation Control and Fire Protection of Commercial Cooking Operations, NFPA 96.

6.2 Transport

WARNING – danger of injury due to machine tipping

- Only qualified personnel may carry out transport works.
- Please note safety notices on the packaging.
- Always transport the machine on a wooden frame only.
- Wear protective gloves and safety shoes.

The packaging is specifically designed to allow the appliances to be moved safely and securely using a pallet jack or a sack truck. For safe transport, the dishwashing machine is supported by a special square-timber frame.



- Execute transport carefully.
- Open packaging using a suitable tool.
- Unpack the dishwashing machine only after transport is completed.

6.3 Perform assembly

Caution

Material damage due to steam escape

Small quantities of steam may escape through the dishwashing machine's door area. It is possible that adjacent furniture can swell up.

- Protect adjacent furniture from swelling up.
- If possible, avoid installing the machine in an area close to sensitive furniture.

Note

Assembly may be performed **only** by a licensed and authorised service technician!

Assembly must be carried out in accordance with the installation drawing.



- Ensure the machine is level in both directions by using a water level.
- Compensate for an uneven floor by adjusting the foot studs (1).
- Table joints must be sealed with detergent-resistant sealing compound (e.g. silicone).
- Check that the machine is stable.

For disposal of packaging materials, see page 57!

7 Commissioning

Warning



Danger of injury from entering a danger zone

Unauthorised persons might be in or enter the danger zone during transport, assembly, commissioning, maintenance and repair work. This can lead to injuries.

- Only permit qualified persons to perform work at the machine.
- Remove unauthorised persons from the danger zone.
- Cordon off danger zone and signpost it for third parties.
- Never remove or disable safety devices on the machine.
- Always wear cut-resistant protective gloves when removing housing parts and when working inside the machine!

7.1 Check prerequisites for commissioning

Caution

Material damage due to steam escape

Small quantities of steam may escape through the dishwashing machine's door area. It is possible that adjacent furniture can swell up.

- Protect adjacent furniture from swelling up.
- If possible, avoid installing the machine in an area close to sensitive furniture.

Prerequisites to be provided by the customer:

- Consistently frost free storage and installation area.
- Anti-slip floor coverings installed in the work area around the dishwashing machine.
- Electrical connection in accordance with the dimensional drawing.
- Fresh water connection in accordance with the dimensional drawing.
- Waste water connection in accordance with the dimensional drawing.

7.2 Perform commissioning



Note

Instruction and initial commissioning may be performed **only** by an authorised service technician! The operator must not use the dishwashing machine before completing training.

To avoid damage to the appliance or dangerous injuries during commissioning of the machine, please note the following points:

- Check supplier parts (e.g. external water processing devices or heating pumps). More detailed information can be found in the relevant operating instructions.
- Ensure that all tools and foreign parts are removed from the machine.
- Make sure that any escaped fluids have been removed.
- Before commissioning, activate all safety systems and door switches (on under-counter machines).
- Check all screw connections sit securely.
- For dishwashing machines with GiO Module, attention must be paid to the "Commissioning certificate for GiO Modules" and the instructions adhered to accordingly.







8 Operation/use

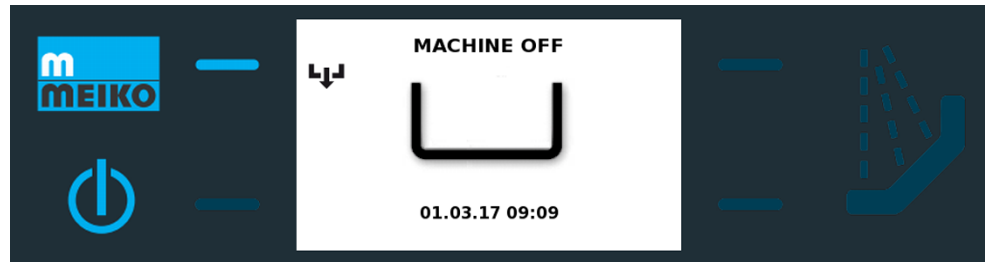

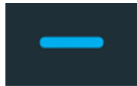





8.1 Glass control panel

The machine is equipped with an operation panel. This includes a total of 7 keys which are used to operate the machine. A display in the centre of the operation panel provides information about the machine's current operational status. In addition, depending on which of the 4 confirmation keys next to the display is pressed, further information and menus are displayed. Inactive confirmation keys are not illuminated.

The meaning of each of the keys and symbols is described below.



Key/symbol	Meaning
	On/Off key Filling/heating on or machine off
	Confirmation key Meaning/function is shown on the display next to the relevant key
	Wash key
	Flashing blue: filling/heating active
	Flashing green: filling/heating active / memory start
	Illuminated blue: machine is ready for operation Illuminated green: washing active
	Service access key/wake-up key
	i-Menu
	Action menu
	Menu self-cleaning/draining

Key/symbol	Meaning
	Programme: cutlery
	Programme: cups
	Programme: dishes
	Programme: pans
	Programme: glasses - gentle
	Programme: glasses - normal
	Programme: glasses - intensive
	Programme: glasses - gentle + cold water rinse
	Programme: glasses - normal + cold water rinse

8.2 Prepare dishwasher



Warning

Risk of injury from contact with chemicals

- Observe the safety data sheets and dosing recommendations of the chemical manufacturers.
- Use eye protection.
- Wear protective gloves.
- Do not mix different chemical products.

Beware

Danger of injury when closing the machine door

When closing the machine door hand injuries can occur if they get caught.

- To close the machine door, use the handle intended for this purpose.

System operators must be very familiar with the Operating Instructions of the dishwashing machine. Incorrect operation may result in personal injury or material damage.



1. Ensure the water supply is available.

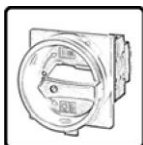

2. Switch on the local mains switch.

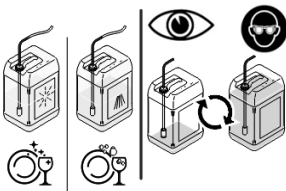

3. Check detergent and rinse aid and top up, if required, see chapter "Replace canister" on page 39.
4. Ensure that the hoses are fed down to the base of the container.



Note

If there is air in the hoses, the automatic dosing will not function correctly. The relevant pipe must be ventilated, see page 45.

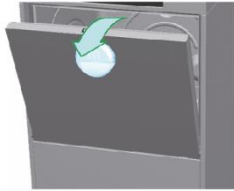

5. Open machine door.

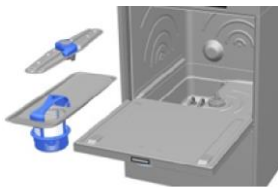

6. Insert filter and washing systems.



7. Close machine door.

8.2.1 Putting the machine into operation



If the display is dark, press the Wake-up key or move the door / hood.



1. Turn on the machine by pressing and holding the on/off key (for one second).

The machine is filling and heating up. The display changes depending on the process stage. The wash key is flashing.

- The display indicates **FILLING**.
- The display indicates **FILLING / HEATING**.
- When ready to operate, the display indicates **READY FOR OPERATION** and the wash key lights up permanently blue.



Note

The time required for the machine to be ready to operate depends on the temperature of the water supply and the installed boiler or tank heating capacity.

8.3 Washing

8.3.1 Putting away washware



- All hollow containers must always be loaded upside down. Otherwise the water will not be drained from the wash ware and brilliant drying will not be possible.



- Place plates, trays and dishes into the baskets at an angle. The inner surfaces face upwards.



- If cutlery holders are used, always insert the cutlery pieces with the handles down.
- Mix up the spoons, knives and forks as much as possible in each cutlery basket, since similar cutlery pieces may nest together.
- Do not put too many cutlery pieces into the individual cutlery baskets.



- Do not stack crockery items on top of each other in the basket. Direct access to the wash water would be more difficult and the washing times would have to be unnecessarily long. Shorter washing with baskets which are not overfilled is more economical.

8.3.2 Select wash programme

- ➔ The dishwashing machine is in **READY FOR OPERATION** mode **ECO MODE I-III**.



1. Select the desired wash programme using the confirmation key.



- ➔ The symbol for the selected wash programme is displayed reversed against the background.



If the wash programme is changed, after approx. 3 seconds the runtime will be briefly displayed. This makes it possible to check that the correct wash programme has been selected.























Programme assignment

Depending on the machine type, the electrical connection and water supply, the programme configuration can vary. The programme configuration is shown in the following tables.

Voltage	Version	M-iClean US			M-iClean UM			M-iClean UM+			M-iClean UL		
		1	2	3	1	2	3	1	2	3	1	2	3
Programmed channel		1	2	3	1	2	3	1	2	3	1	2	3
3N PE 400 V Hot or cold water connection	Glassware	1	2	5	1	2	5	1	2	5	1	2	5
	Crockery	7	9	13	7	9	13	7	9	13	7	9	13
	Bistro	1	8	13	1	8	13	1	8	13	1	8	13
	Universal		-		1	9	14	1	9	14	1	9	14
	Thermolabel*	16	17	19	17	18	20	17	18	20	17	18	21
	A₀ 30*	18	20	21	19	22	23	19	22	23	19	22	24
Cold water connection	Cold water final rinse*	-			15	16	2	-			-		
1N PE 230 V Hot water connection	Glassware	1	2	5	1	2	5	1	2	5	1	2	5
	Crockery	7	9	13	7	9	13	7	9	13	7	9	13
	Bistro	1	8	13	1	8	13	1	8	13	1	8	13
	Universal	-			1	9	14	1	9	14	1	9	14
1N PE 230 V Cold water connection	Glassware	3	4	6	3	4	6	3	4	6	3	4	6
	Crockery	10	12	13	10	12	13	10	12	13	10	12	13
	Bistro	3	11	13	3	11	13	3	11	13	3	11	13
	Universal	-			3	12	14	3	12	14	3	12	14

* These wash programmes are only available for machines with a reinforced tank heater and cannot be selected for standard machines.

M-iClean US

























Programme	Runtime	Boiler temperature	Tank temperature	Pressure level	Rinse water volume	Symbol
[No.]*	[s]	[°C]	[°C]	[1-3]	[l]	
1	90	65	60	1	1,9	
2	120	65	60	2	2,4	
3	180	65	60	1	1,9	
4	180	65	60	2	2,4	
5	180	65	60	3	2,4	
6	240	65	60	3	2,4	
7	90	81	60	1	1,9	
8	120	81	60	2	2,4	
9	120	81	60	2	2,4	
10	180	81	60	1	1,9	
11	180	81	60	2	2,4	
12	180	81	60	2	2,4	
13	240	81	60	3	2,4	
14*	90	2	55	1	2,8	
15*	120	2	55	2	2,8	
16	180	81	74	1	1,9	
17	180	81	74	2	2,4	
18	240	81	74	1	1,9	
19	240	81	74	3	2,4	
20	300	81	74	2	2,4	
21	360	81	74	3	2,4	
22-25	90	65	60	1	1,9	

Programme assignment, see page 32.

* Cold water rinse only for M-iClean UM

Programmes 14-25 only available for machines with higher tank heating capacity (e.g. Thermolabel, A₀ 30).

M-iClean UM / UM+

Programme	Runtime	Boiler temperature	Tank temperature	Pressure level	Rinse water volume	Symbol
[No.]	[s]	[°C]	[°C]	[1-3]	[l]	
1	90	65	60	1	2,4	
2	120	65	60	2	3	
3	180	65	60	1	2,4	
4	180	65	60	2	3	
5	180	65	60	3	3	
6	240	65	60	3	3	
7	90	81	60	1	2,4	
8	120	81	60	2	3	
9	120	81	60	2	3	
10	180	81	60	1	2,4	
11	180	81	60	2	3	
12	180	81	60	2	3	
13	240	81	60	3	3	
14	240	81	60	3	3	
15*	90	2	55	1	3,2	
16*	120	2	55	2	3,2	
17	180	81	74	1	2,4	
18	180	81	74	2	3	
19	240	81	74	1	2,4	
20	240	81	74	3	3	
21	240	81	74	3	3	
22	300	81	74	2	3	
23	360	81	74	3	3	
24	360	81	74	3	3	
25**	90 (240)	75 (81)	63 (74)	3	3,2	

























Programme assignment, see page 32.

* Cold water rinse only for M-iClean UM

** Program 25: MEIKO bottle rack required. Values in brackets apply to Thermolabel and A₀ 30 machines.

Programmes 15-24 only available for machines with higher tank heating capacity (e.g. Thermolabel, A₀ 30, cold water final rinse).

M-iClean UL

Programme	Runtime	Boiler temperature	Tank temperature	Pressure level	Rinse water volume	Symbol
[No.]*	[s]	[°C]	[°C]	[1-3]	[l]	
1	90	65	60	1	2,8	
2	120	65	60	2	3,2	
3	180	65	60	1	2,8	
4	180	65	60	2	3,2	
5	180	65	60	3	3,2	
6	240	65	60	3	3,2	
7	90	81	60	1	2,8	
8	120	81	60	2	3,2	
9	120	81	60	2	3,2	
10	180	81	60	1	2,8	
11	180	81	60	2	3,2	
12	180	81	60	2	3,2	
13	240	81	60	3	3,2	
14	240	81	60	3	3,2	
15*	90	2	55	1	3,5	
16*	120	2	55	2	3,5	
17	180	81	74	1	2,8	
18	180	81	74	2	3,2	
19	240	81	74	1	2,8	
20	240	81	74	3	3,2	
21	240	81	74	3	3,2	
22	300	81	74	2	3,2	
23	360	81	74	3	3,2	
24	360	81	74	3	3,2	
25	90	65	60	1	2,8	

Programme assignment, see page 32.

* Cold water rinse only for M-iClean UM

Programmes 15-25 only available for machines with higher tank heating capacity (e.g. Thermolabel, A₀ 30).

8.3.3 Start wash cycle

Beware

Danger of injury when closing the machine door

When closing the machine door hand injuries can occur if they get caught.

- To close the machine door, use the handle intended for this purpose.



1. Clear the items to be washed (removing any large food residues, napkins, tooth picks, lemon zest etc.).
2. Put the items to be washed into the basket.



3. Open machine door.

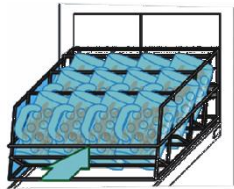

4. Insert the basket into the dishwashing machine.
5. Centre the basket correctly in the basket holder.



6. Close machine door.



7. Ensure that the correct programme has been selected, see page 31.
8. Press the wash key.



The machine washes automatically and switches the programme off after completion. The display indicates the programme's progress.

The cycle time may differ from the set programme running time, if the programme running time is not sufficient to heat up the fresh water to the pre-set temperature. In this case, the cycle time is automatically extended.

8.3.4 Emptying the washware

⚠ Beware

Danger of burns and scalding due to hot rinse water, washware and machine parts

Contact with hot rinse water, washware and machine parts can result in burns/scalding of the skin.

- Wear protective gloves if necessary.
- Let the washware cool down before emptying, if necessary.
- Let the machine cool down before touching machine parts, if necessary.
- Never open the machine door or hood during a wash cycle.
- Only open and close the hood/door using the designated handle(s).

⚠ Beware

Grazing finger on fanwheel if still running

In the case of machines with heat recovery, the tank cover is located behind a fanwheel which continues running after the programme has ended.

- Do not grip using fanwheel when door is open (tank cover to rear)



At the end of the programme, the colour of the wash key is changing from green to blue.



1. Open machine door.

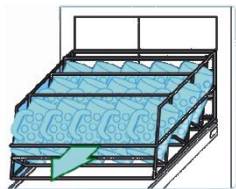

2. Carefully remove the basket.

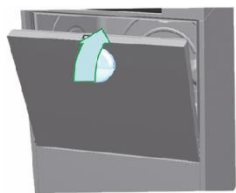

3. Close machine door.

8.4 Fill consumables

8.4.1 Refill of internal storage container



Warning

Risk of injury from contact with chemicals

- Observe the safety data sheets and dosing recommendations of the chemical manufacturers.
- Use eye protection.
- Wear protective gloves.
- Do not mix different chemical products.

1. If required, activate the machine display by pressing the Service/WakeUp key.



The machine indicates the shortage of detergent and/or rinse aid on the display. The internal storage containers must be topped up.



2. Press the illuminated blue button in the lower front panel.
3. Open front panel.



Dosing recommendation

4. Pour the appropriate chemical for dosing into the measuring cup provided.

Maximum filling quantity	M-iClean US	M-iClean UM/UM+/UL
Detergent	400 ml	1000 ml
Rinse aid	80 ml	150 ml



5. Use the funnel to help pour the chemical carefully into the machine until the storage container is full. Check the fill level via the fill level window (1).
 - Blue: rinse aid
 - Transparent: detergent
6. Rinse the funnel and measuring cup.
7. Close the lower front panel using the push button.

8.4.2 Replace canister



⚠ Warning

Risk of injury from contact with chemicals

- Observe the safety data sheets and dosing recommendations of the chemical manufacturers.
- Use eye protection.
- Wear protective gloves.
- Do not mix different chemical products.

Note

The canisters for detergent and rinse aid are located in close proximity to the dishwashing machine.

Note

When using a suction lance which detects whether a canister is empty, a shortage of detergent or rinse aid will be indicated on the display.



A canister is empty.

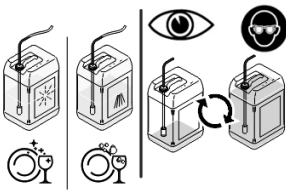

1. Remove the suction lance from the empty canister and insert it into a full canister.
2. If necessary, ventilate the pipelines, see page 45.

8.5 Malfunctions

If the described operational problems occur repeatedly, the cause must be identified.

Occasional malfunctions

Malfunction	Possible cause	Remedy
Dishwashing machine doesn't fill up	No water present	Open the shut-off valve
	Dirt trap clogged	Clean the dirt trap
	Door open	Close door
Final rinse does not spray	No water present	Open the shut-off valve
	Dirt trap clogged	Clean the dirt trap
Streaks / smears on the washware	Unsuitable rinse aid	Change product
	Incorrect dosing quantity	Adjust dosing quantity
	Water pre-treatment defective	Check water pre-treatment
Strong formation of foam in the wash tank	Dirt level too high	Prepare the washware more thoroughly/change tank water more frequently
	Manual dishwashing detergent used	Do not use a foaming manual dishwashing detergent for precleaning or for cleaning the machine. Foam can cause malfunctions in the dishwashing machine and a poor washing result.
	Unsuitable detergent	Change product
	Unsuitable rinse aid	Change product

As a rule, faults that are not described here require assistance from an authorised service technician. Please contact your subsidiary or authorised dealer.

8.5.1 Messages



When a malfunction occurs, a grey or red message is shown on the display depending on the nature of the malfunction.

- Grey messages can be acknowledged using the relevant confirmation key.
- Red messages usually require the deployment of an authorised service technician.

- When these messages occur:

- | |
|---|
| 1, 100, 102, 104, 107, 108, 109, 110, 150, 201, 203, 204, 206, 207, 208, 209, 330, 420, 425, 427, 880, 901/902, 931-945, 960. |
|---|

Not possible to continue working

- Switch off on-site power supply
- Close on-site water supply
- Call a service technician!

No.	Display text	Measures/remedial action
6	Programme cancelled prematurely	<ul style="list-style-type: none"> • Start wash cycle again
7	Door not closed	<ul style="list-style-type: none"> • Close the door
8	Door switch signals not identical: Switch left: "1" Switch right: "0"	<ul style="list-style-type: none"> • Call a service technician! • Possible to continue work at limited capacity
9	Door switch signals not identical: Switch left: "0"; Switch right: "1"	<ul style="list-style-type: none"> • Call a service technician! • Possible to continue work at limited capacity
11	Carry out maintenance	<ul style="list-style-type: none"> • Possible to continue working • Call a service technician!
12	Code entry wrong!	<ul style="list-style-type: none"> • Enter correct code
14	Heat lost through open door!	<ul style="list-style-type: none"> • Close door to prevent energy loss
15	Heat recovery cancellation	<ul style="list-style-type: none"> • Allow the heat recovery process to run to completion.
17	Emptying / closing the door	<ul style="list-style-type: none"> • Close the door
18	Water change / close door	
100	First fill error	<ul style="list-style-type: none"> • Not possible to continue working • Call a service technician!
101	Drainage level not reached	<ul style="list-style-type: none"> • Check the drainage sieve, clean if necessary • Call a service technician if needed
103	Tank temperature not reached	<ul style="list-style-type: none"> • Possible to continue working • Call a service technician
106	Wash time increase insufficient	<ul style="list-style-type: none"> • If this message reoccurs, call a service technician
111	Water loss in wash tank	<ul style="list-style-type: none"> • If this message reoccurs, call a service technician
112	Forced drainage due to permanently filled wash tank	<ul style="list-style-type: none"> • Change the water or drain the machine at least once a day
114	Fine/coarse sieve missing	<ul style="list-style-type: none"> • Correctly insert fine/coarse sieve • If this message reoccurs, call a service technician

No.	Display text	Measures/remedial action
115	Drain pump active after triggering of the safety level	<ul style="list-style-type: none"> Possible to continue working
116	Refill error in wash tank	<ul style="list-style-type: none"> If this message reoccurs, call a service technician
117	Top wash system blocked/missing	<ul style="list-style-type: none"> Ensure wash arm system can move freely If applicable, insert wash arm system
118	Bottom wash system blocked/missing	<ul style="list-style-type: none"> Where appropriate, remove dirt particles and ferrous metal particles from the magnet
127	Temperature increase not reached	<ul style="list-style-type: none"> If this message reoccurs, call a service technician
200	Boiler level not reached on time during filling	<ul style="list-style-type: none"> Open the local water supply Check pre-filter/sieve and clean, if necessary
205	Maximum final rinse cycles insufficient	<ul style="list-style-type: none"> Sort washware correctly Possible to continue working
212	Forced drainage due to permanently filled boiler	<ul style="list-style-type: none"> Change the water or drain the machine at least once a day
301	Lack of rinse aid	<ul style="list-style-type: none"> Refill / replace canister
311	Lack of detergent	<ul style="list-style-type: none"> Check the position of the suction lance and clean if necessary
406	Advance report: cartridge nearing end of life	<ul style="list-style-type: none"> Have a replacement cartridge ready Replace when notification 407 appears
407	Change demineralisation cartridge	<ul style="list-style-type: none"> Replace demineralisation cartridge
408	Change osmosis system pre-filter	<ul style="list-style-type: none"> Replace pre-filter
410	Water supply reverse osmosis module disturbed	<ul style="list-style-type: none"> Open water inlet valve Check pre-filter/sieve and clean or replace, if applicable
421	Insufficient water in holding tank	<ul style="list-style-type: none"> Open water inlet valve Where appropriate, call a service technician
422	Max. level not reached in holding tank	
423	Water feed into holding tank insufficient	
426	Osmosis membrane blocked/dirty	<ul style="list-style-type: none"> Possible to continue working Check pre-filter and replace if necessary Call a service technician!
500	Energy optimisation active	<ul style="list-style-type: none"> No action required
501	Energy optimisation active Tank temperature not reached	<ul style="list-style-type: none"> Possible to continue working Call a service technician!
502	Energy optimisation active Wash time increase in tank insufficient	<ul style="list-style-type: none"> Possible to continue working If this message reoccurs, call a service technician
503	Energy optimisation active Temperature increase not reached	<ul style="list-style-type: none"> If this message reoccurs, call a service technician
504	Energy optimisation active Final rinse temperature not reached	<ul style="list-style-type: none"> Call a service technician!
505	Energy optimisation active Wash time increase on final rinse insufficient	<ul style="list-style-type: none"> If this message reoccurs, call a service technician

No.	Display text	Measures/remedial action
892	Communication with SMART WIRE node addr. 13	<ul style="list-style-type: none"> • Possible to continue working • Call a service technician!
963	Bluetooth access error	<ul style="list-style-type: none"> • Confirm message • Possible to continue working • Call a service technician!
969	Low battery	<ul style="list-style-type: none"> • Confirm message • Able to continue working at limited capacity • Call a service technician!
971	Operating panel re-initialising	<ul style="list-style-type: none"> • If this message reoccurs, call a service technician

If an error message is displayed that is not in this list, please contact the authorised service technician.

8.6 Shutting down the dishwasher



1. Press on/off key.



✓ 2. Confirm request with the relevant confirmation key.

➔ The dishwashing machine will self clean.

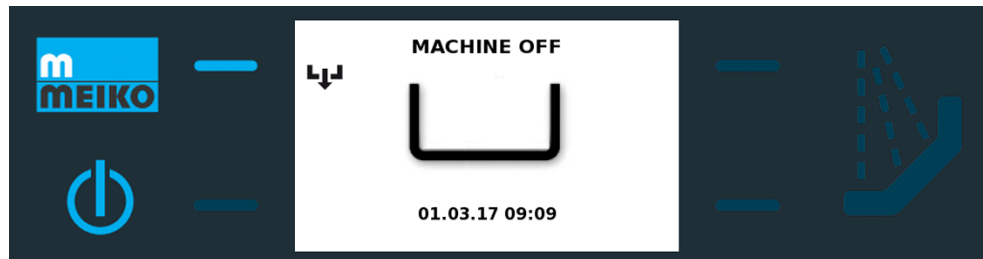

➔ Once the self-cleaning process is complete, the dishwashing machine will switch to **MACHINE OFF** mode.

8.7 Change authorisation level



Note

The dishwashing machine must be in **MACHINE OFF** mode.

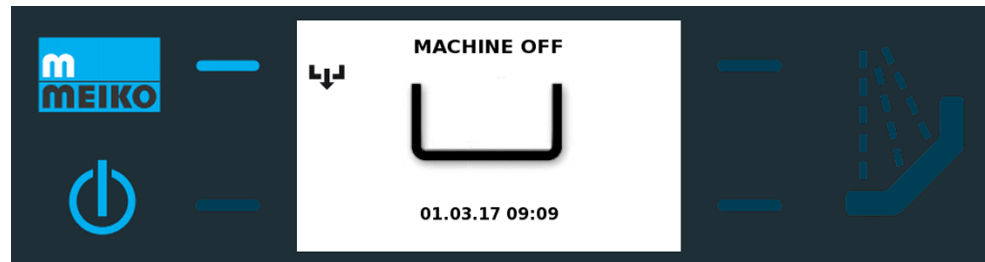

1. Press and hold the Service access key for approximately three seconds.

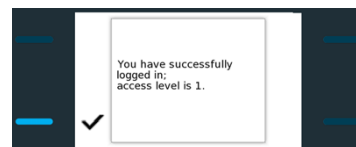

2. Enter the service code for the required authorisation level.



3. Confirm the message.

Authorisation level 1 – user configuration level

Read settings (**service code: 10000**)

The user can view the user settings.

Read/modify settings (**service code 10001**)

The user can carry out all functions required for normal operation and configure the settings.

Authorisation level 4 – extended configuration level

Read settings (**service code: 40000**)

The user can view the extended settings.















Read/modify settings (**service code 40044**)

In addition to the functions and settings for authorisation level 1, the operator can view/edit all the relevant parameters for the dosing equipment. The i-menu shows all variable parameters in the corresponding tabs (dosing system, wash programs).







**Note**

Certain menu functions in i-menu and the action menu have to be enabled by an authorised service technician before the operator can use them (reset counter, etc.).

i-menu

	Symbol	Level	Description
Languages		1, 4	Set display language
Wash tank		1, 4	Set automatic hood opening and descaling parameters View status
Final rinse		1, 4	View status
Chemicals		1	Set dosage quantity for detergent and rinse aid
Water treatment		1	Set degree of hardness and treatment parameters
Heat recovery		1	No user settings
Energy optimisation		1, 4	No user settings
Global		1	Set wash programme channels and Bluetooth communication
Operational times		1,4	View batches, operational times, etc.
Daily protocol		1,4	View archived operational times, events, etc.
Wash programmes		4	Set quantity of rinse aid and fine tune dosing
Settings		1,4	Set date/time, reset counter, notification settings
General		1,4	View software version, machine serial number, machine type
Dosing system		4	Dosing parameters for the dosing technician

Action menu

	Symbol	Level	Description
Ventilate detergent pipe		1, 4	Starts detergent or rinse aid dosing pump to ventilate the transport pipes when required, e.g., when the canisters are empty during operation.
Ventilate rinse pipe		1, 4	
Manually start water change		1, 4	If automatic wash tank water regeneration with fresh water is insufficient, an additional water change may be necessary.
Descaling		1, 4	Starts descaling programme.
Reset pre-filter interval counter		1, 4	Reset the interval for the pre-filter change of the reverse osmosis module.

8.8 Ventilating the pipes

The detergent or rinse aid pipes must be ventilated, if air is sucked in from the dosing equipment. This occurs if a storage container is completely emptied during operation, or if one of the suction lances is not positioned right down to the base of the container.

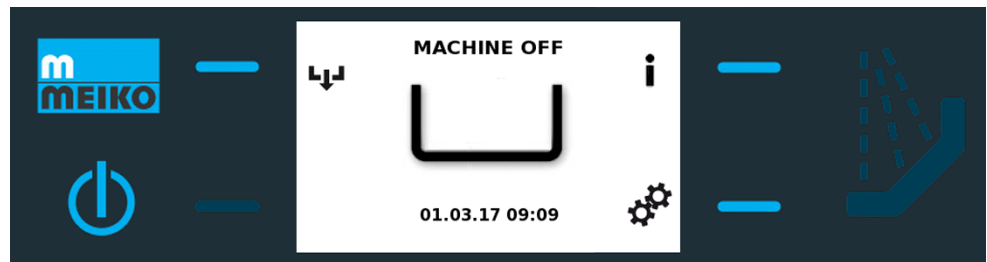

1. Switch to authorisation level 1 **User configuration level**, see page 43.



2. Call up the action menu using the relevant confirmation key.

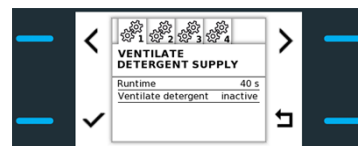
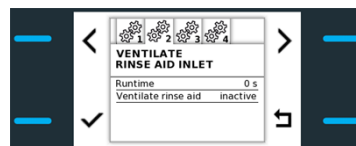

3. Select the required submenu.



4. Start the ventilating procedure by using the relevant confirmation key.

8.9 Perform a manual water change

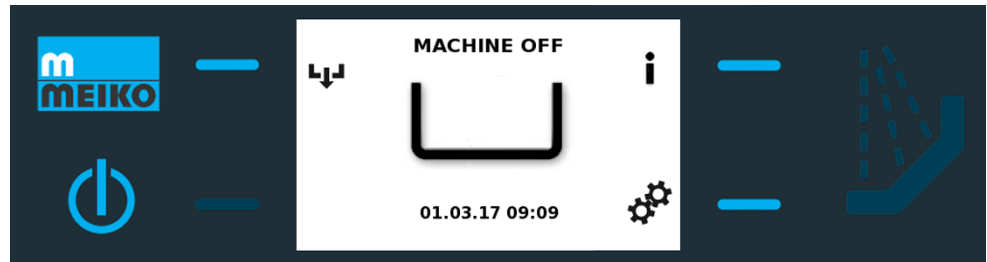

1. Switch to authorisation level 1 **User configuration level**, see page 43.



2. Call up the action menu using the relevant confirmation key.

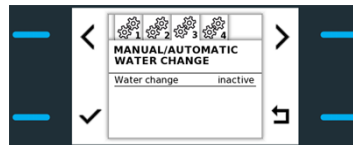

3. Select the required submenu.



4. Start the water change by using the relevant confirmation key.

8.10 Reset the counter



Note

In order to be able to reset counters in security access level 1, this function must be separately enabled by an authorised MEIKO service technician. Resettable counters:

- Maintenance counter
- Reverse osmosis (UO) filter insert

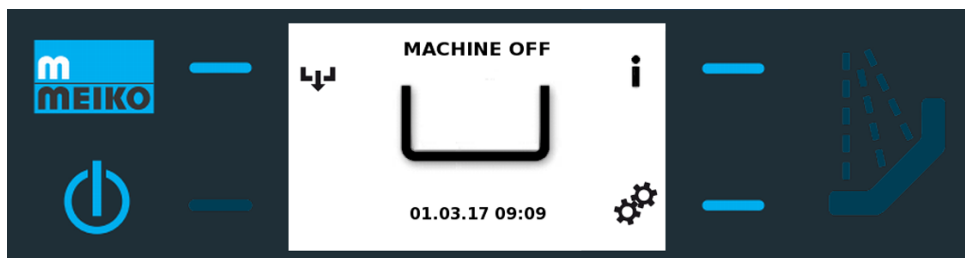

1. Switch to security authorisation level 1 **user configuration level**, see page 43.



2. Call up the i-menu using the relevant confirmation key.



3. Switch to the **Settings** tab page.



4. Select the item **reset counter**.



5. Confirm the selection.

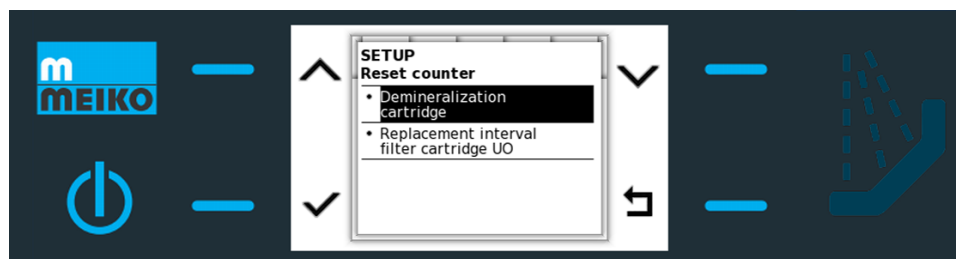

- ✓ 6. Select the counter to be reset.
- ✓ 7. Confirm the selection to reset the values.



Note

The counters for the water treatment options can also be reset via security authorisation level 4 **Extended configuration level**, see page 43.

8.11 Adjust dosing quantity

1. Switch to security authorisation level 1 user configuration level, see page 43.
-  2. Call up **i-menu** using the relevant confirmation key.
3. Select the **CHEMICAL PRODUCT** tab
4. Select and confirm the **Parameter** item.
5. Select and confirm the **Rinse aid dosing quantity** or **Detergent dosing quantity** item.
6. Change the value with **+/-** and confirm.



8.12 Activate/deactivate Bluetooth interface

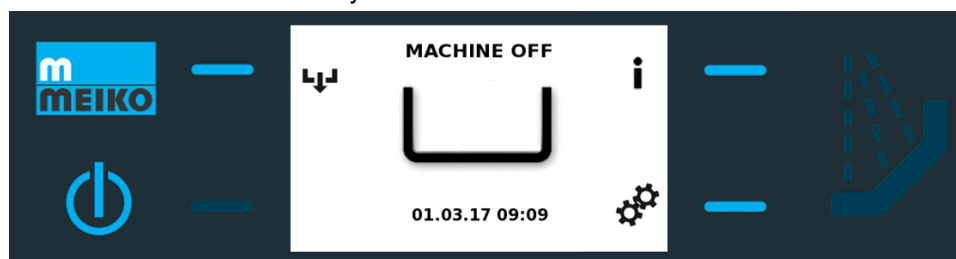

Note

The Bluetooth interface allows the service technician to read the machine's data and is used for software updates. It is switched on as standard. If necessary, the interface can be deactivated by the user.



1. Switch to security authorisation level 1 **user configuration level**, see page 43.
-  2. Call up **i-menu** using the relevant confirmation key.
-  3. Switch to the **global** tab.
- ✓ 4. Select the item **parameters**.
- ✓ 5. Confirm the selection.
- ✓ 6. Select the item **release Bluetooth communication**.

- ✓ 7. Confirm the selection.
- ✓ 8. Select the item **no**.
- ✓ 9. Confirm the selection.

8.13 Private Label 2.0

If desired, one or more individual motifs can be shown on the dishwashing machine operating panel. The user can choose between a screen saver during operation (slide show) and/or a welcome screen when the supply voltage is switched on.

The option can be selected directly when ordering the machine, or can be ordered later from the dealer/service partner.

The welcome screen is just displayed for a few seconds after switching on the power supply.

The screen saver will be displayed after 6 minutes of no user action if the machine is in the READY FOR OPERATION/ ECO MODE status. The uploaded images are displayed in a slide show (interval of 5 seconds). The interval can be changed via Settings - Display - Single image display duration. The screen saver can be left by means of any user action.

- | | |
|--|--|
| <p>1. Have the machine's serial number ready. It can be found on the rating plate or can be read off the operating panel by pressing (3 s) the service access key.</p> | <p>2. Send the serial number in the e-mail subject to privatelabel@meiko-global.com and receive a voucher code in response. This only works if you order the option in advance!</p> |
|--|--|

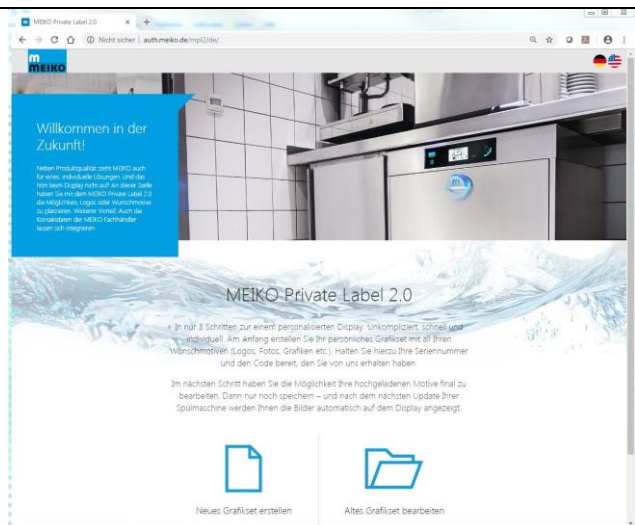

- | | |
|--|--|
| <p>3. Go to the https://privatelabel.meiko-global.com website.</p> | <p>4. Click on the "Create new graphics set" button.</p> |
|--|--|

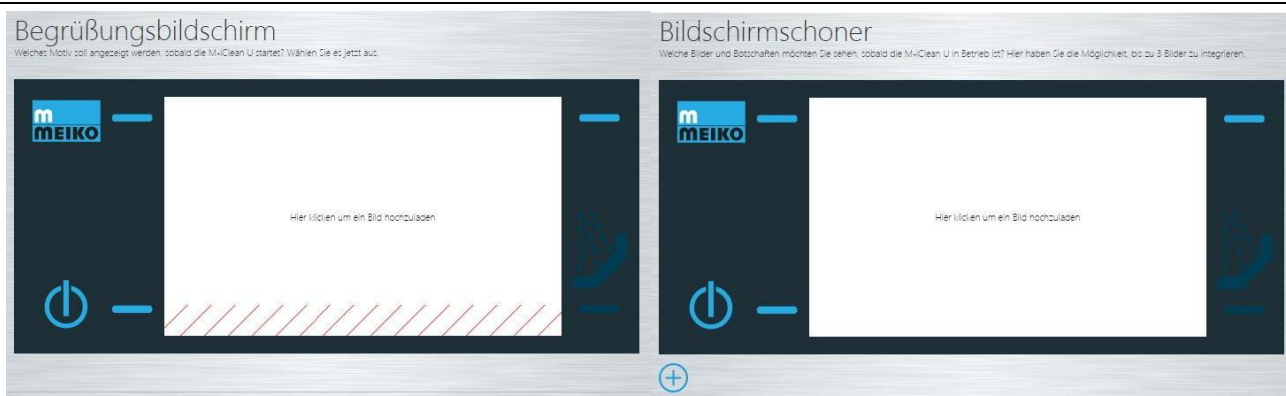

The selection menu for uploading the welcome screen and screen saver appears.
+ can be used to upload two additional screen saver motives, if required.

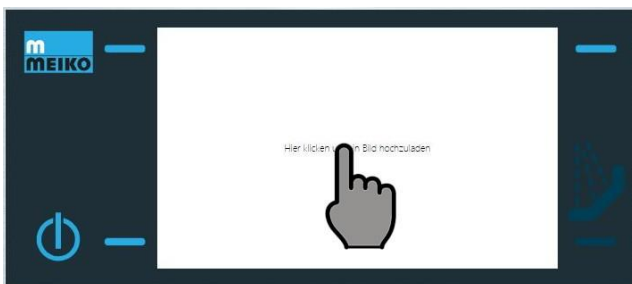

5. Click in the display to upload.

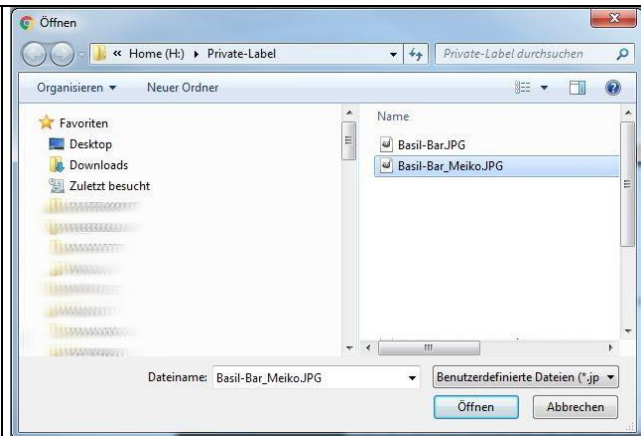

6. Select file.



7. Adjust the size and position, rotate if necessary. Confirm by ticking the checkbox.



8. Assess the result, edit or discard if necessary. Repeat steps 5-7 for more motives.

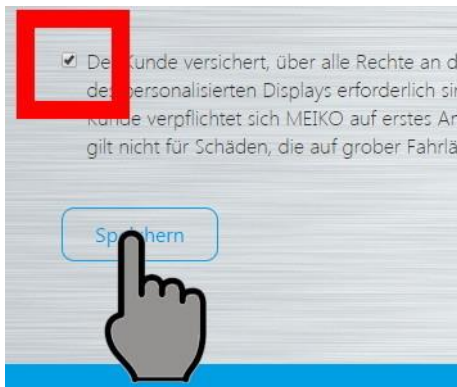

9. Tick the checkbox before saving.



10. Enter the serial number and voucher code.

<p>Erfolgreich gespeichert.</p> <p>Ihre Wunsch-Motive wurden erfolgreich gespeichert.</p> <p><small>Nach dem nächsten Update der M-Clean U werden sie Ihnen automatisch auf dem Display angezeigt. Viel Freude mit Ihrem personalisierten Produkt!</small></p>	
<p>That's all! Your Private Label will be transferred to the machine during the service technician's next visit.</p>	

8.13.1 Setting waiting time for Private Label

1. Switch to authorisation level 1, see page 43.
2. The waiting time can be changed in the i menu under **Settings- Display- 2nd waiting time until Start Private Label (0 means: always ON= no screen protector or 2nd waiting time deactivated)**.
3. Press the MEIKO key for 3 seconds and confirm the request to log off from the current session.

8.14 Setting the waiting time for dimming the display brightness

1. Switch to authorisation level 1, see page 43.
2. The waiting time until dimming can be changed in the i-menu under **Settings- Display- Waiting time until TFT 50% reduced (0 means: always ON= no dimming)**.
3. Press the MEIKO key for 3 seconds and confirm the request to log off from the current session.

9 Maintenance and cleaning



⚠ Warning

Danger to life from electric shock

Contact with live electrical parts can lead to serious injury or death.

- Work at or repairs to the electrical system must be conducted by a qualified electrician who complies with the electrotechnical rules.
- Disconnect the machine from the power supply before working on the electrical system. To do this, turn the local mains switch to **OFF** and ensure that it can't be switched back on again.



⚠ Warning

Danger to life from electric shock if cover panels are open

If the machine is operated without cover panels, electrified parts are freely accessible. Contact with these parts can lead to serious injury or death.

- Disconnect the machine from the power supply before opening the cover panels. To do this, turn the local mains switch to **OFF** and ensure that it cannot be switched back on again.
- Attach all cover panels before placing the machine back in operation.



⚠ Warning

Danger of injury from entering a danger zone

Unauthorised persons might be in or enter the danger zone during transport, assembly, commissioning, maintenance and repair work. This can lead to injuries.

- Only permit qualified persons to perform work at the machine.
- Remove unauthorised persons from the danger zone.
- Cordon off danger zone and signpost it for third parties.
- Never remove or disable safety devices on the machine.
- Always wear cut-resistant protective gloves when removing housing parts and when working inside the machine!

Caution



Environmental damage due to improper disposal of liquids

Environmentally hazardous liquids (e.g. grease and oils, hydraulic oils, coolants, cleaning agents containing solvents etc.) may be used during work on and with the machine. Improper disposal of these liquids can damage the environment.

- Always capture, store and transport liquids in suitable containers.
- Never mix liquids.
- Dispose of liquids properly in accordance with local requirements.

9.1 Maintenance



Note

Maintenance work must only be carried out by an authorised in-house technician or an authorised service technician.

Cleaning work and changing pre-filter in dishwashers with GiO Module must be carried out by trained operators.

The dishwasher has been designed to keep the need for cleaning, care and maintenance to a minimum.

However, for reliable, safe and long-term function of the machine, and in the interest of hygiene and cleanliness, correct care and maintenance are necessary.

We recommend concluding a maintenance contract with our subsidiary in order to ensure a long service life of the dishwasher.

A functional test on all safety systems of the machine is carried out during every regular maintenance.

- Comply with the maintenance intervals prescribed in these operating instructions.
- Please note the maintenance instructions for the individual components in these operating instructions.
- Carefully dispose of any cleaning products that could harm the environment.

9.2 Maintenance table

Maintenance work Visual inspection	U= M-iClean H=M-iClean	Checked	Cleaned	Replaced	Maintenance requirement
1. Error memory					
Check error memory for unusual events	U/H				annually
2. Pumps					
Check pumps for leaks and any visible damage	U/H				annually
Check pumps for pump rotor noise and function	U/H				annually
3. Wash tank, wash and rinse system					
Functional and visual tests of wash and rinse arms	U/H				annually
Replace sealing rings on wash arms	U/H				annually
Check air trap on tank and clean if necessary	U/H				annually
Check tank level control for leaks	U/H				annually
Check sieves and filters	U/H				annually
Check rack holder/guide for damage	U/H				annually
Check wash and rinse systems for leaks	U/H				annually
Check water level in tank	U/H				annually
Check door seal	U				annually
Check seal on coarse sieve/drain pump	U				annually
Check tank and boiler heating	U/H				annually
4. Casing					
Check casing, tank and covers for damage and correct operation	U/H				annually
Check door and door counter balance for correct operation	U				annually
5. Hood and hood counterbalance					
Check hood movement for running noise	H				annually
Remove bearing block <ul style="list-style-type: none"> • Check rollers in bearing block • Clean drain hole in hood 	H				annually
Visually check hood mounting	H				annually
Clean hood guide rails and back wall seal	H				annually
Check handles sit firmly and, if necessary, tighten screws	H				annually
Check life span of springs and chains <ul style="list-style-type: none"> • Replacement • HM/HL and EcoTemp ET 15.1/17.1: replace guide block for protective rod and mounting plate for springs • HXL: replace guide block, only replace mounting plate if necessary 	H				annually after 650,000 loads or 12 years
Clean running surfaces on square tubing	H				annually
6. Fresh water installation					
Check valves, clean dirt trap	U/H				annually
Check that the boiler level control/air trap are not leaking	U/H				annually
Check boiler, hoses, clamps and plastic parts do not leak	U/H				annually
Check boiler drainage system does not leak	U/H				annually
7. Wastewater installation					
Replace flap on ventilation valve	U/H				annually
Check operation of drain pump during drainage	U/H				annually
Check pumps, hoses and wastewater heat exchangers (optional extra) are not leaking	U/H				annually

8. Detergent dosing								
Replace peristaltic hose and seals on the nozzles					U/H			annually
Check detergent dosing system is working and not leaking					U/H			annually
9. Rinse aid dosing								
Replace peristaltic hose and seals on the nozzles					U/H			annually
Check rinse aid dosing system is working and not leaking					U/H			annually
10. Test run including functional test of whole machine								
Check filling and heating until it is ready for operation					U/H			annually
Visual inspection of the entire machine for leaks					U/H			annually
Check results of test wash and rinse					U/H			annually
11. Options								
Integrated reverse osmosis system (if applicable)								
Visually check whole system for leaks					U/H			Annually
Change pre-filter (standard membrane (<0.1 mg/l))					U/H			Every six months
Change pre-filter (chlorine-resistant membrane (≥ 0.1 and ≤ 2.0 mg/l))					U/H			Every three months
Check fine sieve insert and choke in concentrate pipeline					U/H			Annually
Check correct function of concentrate drain and check for deposits					U/H			Annually
Fill in separate log, "Certificate of Commissioning, GiO"					U/H			Annually
Partial demineralisation (PD) / Full demineralisation (FD) (if available)								
Functional test					U/H			Annually
Heat retention system (if applicable)								
Visually check lever arm					H			Annually
Check sheeting for damage					H			Annually
Functional test					H			Annually
Exhaust air heat recovery (if applicable)								
Functional test of fan					U/H			Annually
Functional test of solenoid valve					U/H			Annually
Visual inspection and leak test					U/H			Annually
Thermal disinfection (if available)								
Replace hood seal profile (HL)					H			Annually
12. Water quality, temperature								
Drinking water	°C	°dH	°CH	µS/cm	U/H			annually
Water quality after water treatment (if applicable)		°C	°dH	µS/cm	U/H			annually
13. Electrical safety check (certificate is optional)								
Carry out the visual inspection					U/H			annually
Check the protective earth conductor					U/H			annually
Insulation resistance measurement					U/H			annually
Measure current on protective earth conductor					U/H			annually

9.3 Daily cleaning

⚠ Beware

Danger of burns and scalding due to hot rinse water, washware and machine parts

Contact with hot rinse water, washware and machine parts can result in burns/scalding of the skin.

- Wear protective gloves if necessary.
- Let the washware cool down before emptying, if necessary.
- Let the machine cool down before touching machine parts, if necessary.
- Never open the machine door or hood during a wash cycle.
- Only open and close the hood/door using the designated handle(s).

Caution

Material damage due to water ingress

Electrical cables and electronic components can be damaged if they come into contact with water.



- The dishwashing machine, switch cabinets and other electrical components must **never** be sprayed with a hose or high pressure cleaner.
- Make sure that no water can enter the machine unintentionally.
- If installed at ground level, **never** flood the surrounding room.

The machine is emptied, see section see page 42.

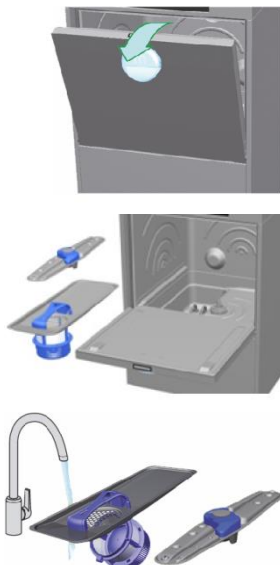

1. Open machine door.

2. Remove filter and washing systems.

3. Remove all food residues which are stuck to the tank, the tank heater and the filters using a brush.

4. Remove the washing and rinse arm and rinse thoroughly under running water. When doing this, pay particular attention to the nozzles!

Do not use a foaming manual dishwashing detergent for pre-cleaning or for cleaning the machine. Foam causes malfunctions and can result in a poor wash.



5. To ensure that the sensor detects the rotation of the washing arm, remove all dirt particles and ferrous particles which are sticking to the magnet (1).



6. Clean the inner chamber of the tank.
7. Inspect the main pump filter for contamination daily and clean as necessary. To clean, remove the filter and rinse thoroughly under running water.
8. Reinstall **all** parts.

9.4 Cleaning the stainless steel surfaces

Caution

Material damage due to incorrect cleaning

Cleaning of parts made of stainless steel with unsuitable cleaning agents, care products and cleaning utensils leads to damage, deposits or discolourations on the machine.

- Never use aggressive cleaning or scouring agents.
- Never use cleaning agents that contain hydrochloric acid or bleaches based on chlorine.
- Do not use cleaning utensils previously used to clean non-stainless steel.

Caution

Material damage due to aggressive cleaning products

The use of aggressive cleaning and care products near the machine can cause damage to the machine due to their fumes.

- Make sure that the cleaning and care products cannot have direct contact with the machine.
- Do not use aggressive cleaning agents (e.g. aggressive tile cleaner) to clean the surrounding area.
- Please observe the notes on the product packaging.
- In case of uncertainty, request information from the suppliers of these products.

We recommend that, when required, the stainless steel surfaces are cleaned exclusively using cleaning and care products that are suitable for stainless steel.

- Lightly soiled parts can be cleaned with a soft and possibly damp cloth or sponge. For moistening we recommend only using demineralised water.
- In order to prevent limescale, we recommend wiping the surfaces thoroughly dry after cleaning.

9.5 De-scaling



Warning

Danger of injury from contact with acids

Descaling agents can cause damage to health if they come into contact with skin or eyes or are swallowed.

- Use eye protection.
- Wear protective gloves.
- Contact a physician immediately if chemicals or water containing chemicals (rinse water) are swallowed.
- Please take note of the manufacturer's safety instructions.

Operating the machine using hard water can result in the build up of limescale deposits in the boiler and the tank interior. If this occurs, it is necessary to descale the tank interior, boiler housing, tank heating, boiler heating and the washing and rinse systems.

Using service code "40044" you can reach authorisation level 4 (see page 43). Here the "descale" function (for the wash tank) can be selected from the pull-down menu.



The descaling time and temperature can be adjusted in the i-Menu under the tab "Dosing technology".

- For descaling only use products suitable for industrial dishwashing machines.

9.6 Spare parts

Please provide the following information on any query and/or when ordering spare parts:

Type:
SN:

(This information can be found on the type plate, see page 15.)

10 Dismantling and disposal

In addition to valuable raw materials and recyclable materials, the packaging and the old device may also contain substances that are harmful to health and the environment and were required for the function and safety of the old device.

Please do not dispose of your old device in residual waste. Instead, contact your dealer or the collection points set up in your community for information regarding the disposal of your old device.

10.1 Disposal of packaging materials

All the packaging materials are recyclable. The following materials are used:

- Square timber frame
- Plastic sheeting (PE film)
- Cardboard packaging (for protecting edges)
- Packaging strap (steel strip)
- Packaging strap (plastic (PP))



Note

The square timber frame consists of untreated raw pine / spruce. In order to guard against pests, country-specific import regulations may also stipulate the use of treated wood.

10.2 Dismantling and disposal of the old device

Warning



Risk of injury from contact with chemicals

- Observe the safety data sheets and dosing recommendations of the chemical manufacturers.
 - Use eye protection.
 - Wear protective gloves.
 - Do not mix different chemical products.
-
- Where appropriate, rinse machine components, containers, dosing units and hoses with fresh water to remove chemical residues. Wear suitable clothes (gloves, safety glasses) for this.



The device is marked with this symbol. Please observe the local regulations for proper disposal of your old device.

The components should be separated by material for recycling.

11 Abbreviations

Abbreviation	Meaning
GiO	GiO module, integrated reverse-osmosis system
pH	The pH value denotes the acidity of liquids
LpA	LpA denotes the emission sound pressure levels at the workplace
dB	Decibel, unit of sound pressure level.

12 Index

A	
A0 control.....	19
Abbreviations.....	57
Action menu.....	45
Adjust dosing quantity.....	47
Assembly.....	22
Authorisation level	
action menu.....	45
Advanced.....	43
i-menu.....	44
User.....	43
B	
Blue operating concept.....	15
Bluetooth interface	
Deactivate.....	47
Bottle rack.....	18
C	
Change authorisation level.....	43
Change of products.....	17
Checking the condition at delivery.....	23
Cleaning the stainless steel surfaces.....	55
cold water final rinse.....	18
ComfortAir.....	17
Commissioning.....	27
prerequisites.....	27
D	
Daily cleaning.....	54
Delivery contents.....	5
De-scaling.....	56
Designation of machine type.....	4
Detergent.....	16
Detergent and rinse aid.....	16
Dimensions.....	21
Dimming display brightness.....	50
Dismantling.....	57
Dismantling and disposal.....	57
Disposal of packaging materials.....	57
Disposal of the old device.....	57
Dosing equipment.....	16
E	
EC/EU declaration of conformity.....	22
Eco mode.....	20
F	
Fill consumables.....	38
Forced drainage.....	20
Functional description.....	13
Fundamental safety and accident prevention regulations.....	11
G	
GiO-MODULE.....	17
Glass control panel.....	28
Glasswashers.....	18
H	
heat recovery.....	17
I	
i-menu.....	44
Intended use.....	10
L	
LED indicator handle.....	15
Liability and warranty.....	5
M	
Machine weight.....	20
Maintenance.....	51
Maintenance and cleaning.....	50
Maintenance table.....	52
Malfunctions.....	39
Menu overview	
action menu.....	45
i-menu.....	44
Messages.....	40
N	
Noise emissions.....	21
Notes in the instructions.....	6
Notes on the operating instructions.....	4
O	
Operation/use.....	28
Options.....	17
Thermal disinfection.....	19
Overview illustration.....	14
P	
Perform a manual water change.....	46
Perform assembly.....	26
Perform commissioning.....	27
Personalise machine.....	48
Prerequisites for assembly.....	23
Private Label 2.0.....	48
Product description.....	13

Programme tables		Shutting down the dishwashing machine	42
M-iClean UL	35	Spare parts	56
M-iClean UM / UM+	34	Suction lances.....	17
M-iClean US	33	Switching off.....	42
R		Symbol explanation.....	6
Recess dimensions.....	21	T	
Refill of internal storage container	38	Technical data.....	20
Related documents.....	5	Thermal disinfection.....	19
replace canister	30, 39	Thermolabel disinfection	19
Requirements for the fresh water connection.....	23	Transport.....	26
Requirements for the installation area.....	23	U	
Requirements for the personnel	8	Unintended use.....	11
Requirements for the waste water connection	23	V	
Requirements to the electrical connection.....	25	Ventilating the pipes	45
Reset counter		W	
demineralisation cartridge	46	Waiting time Private Label	50
maintenance counter	46	Washing	
reverse osmosis (UO) filter insert	46	emptying the washware	37
Reset the counter	46	Preparation	29
Residual risks	9	putting in washware	31
Rinse aid.....	16	putting the machine into operation.....	30
S		Select wash programme	31
Safety.....	6	Start wash cycle	36
Safety instructions on the machine.....	8	Water pressure	21
Safety symbols in the instructions	7	What to do in the event of an emergency.....	13
Service codes	43		



The clean solution



MEIKO Maschinenbau GmbH & Co. KG

Englerstraße 3
77652 Offenburg

Germany

www.meiko-global.com

info@meiko-global.com

Design and construction subject to change without prior notice!