

M-iClean H

Hood type dishwashing machine

Operating instructions

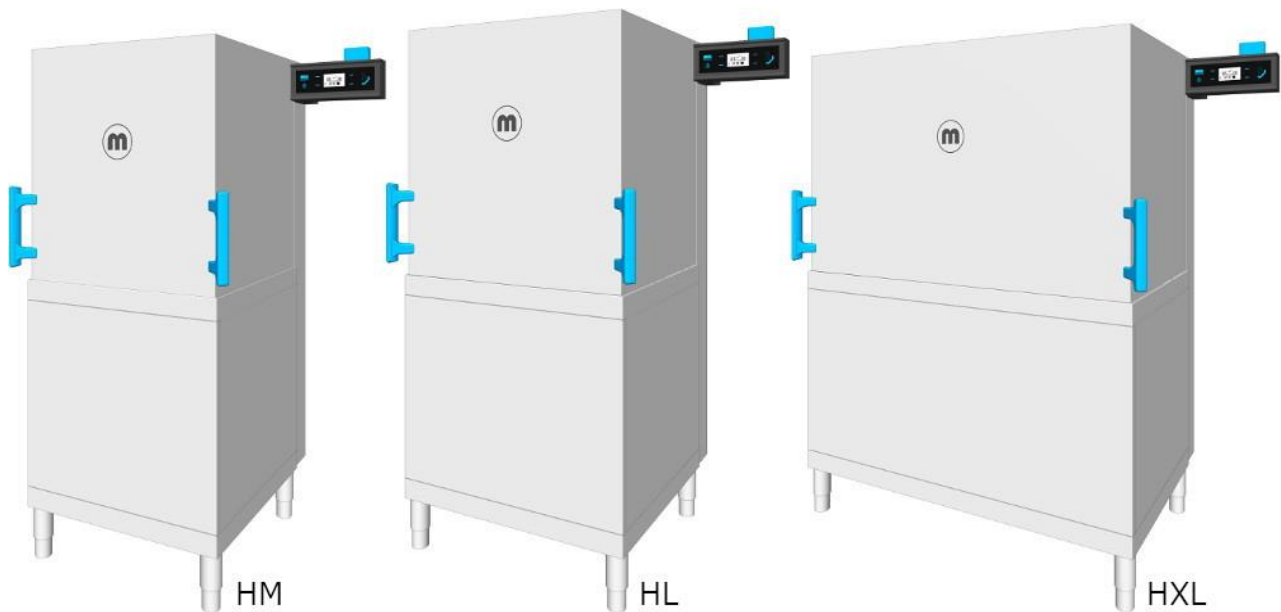

EN



Read operating instructions before using the machine!

Contents

1	NOTES ON THE OPERATING INSTRUCTIONS	5
1.1	Product identification	5
1.2	Delivery contents	6
1.3	Related documents	6
2	LIABILITY AND WARRANTY.....	6
3	SAFETY	7
3.1	Symbol explanation	7
3.1.1	<i>Notes in the instructions</i>	7
3.1.2	<i>Safety symbols in the instructions</i>	8
3.2	Requirements for the personnel	9
3.3	Residual risks	9
3.4	Intended use	11
3.5	Foreseeable misuse	11
3.6	Fundamental safety and accident prevention regulations	12
3.7	What to do in the event of an emergency	14
4	PRODUCT DESCRIPTION	14
4.1	Functional description	14
4.2	Overview illustration	15
4.3	Type label	16
4.4	Indicator light	17
4.5	Blue operating concept	17
4.6	Detergent and rinse aid	17
4.6.1	<i>Detergent</i>	18
4.6.2	<i>Rinse aid</i>	18
4.6.3	<i>Dosing equipment</i>	18
4.6.4	<i>Suction lances</i>	18
4.6.5	<i>Change of products</i>	18
4.7	Options	19
4.7.1	<i>GiO-MODULE</i>	19
4.7.2	<i>Automatic hood system</i>	19
4.7.3	<i>Rack detection (Intelli-Start) (option)</i>	19
4.7.4	<i>PowerWash</i>	19
4.7.5	<i>Disinfection control</i>	19
4.7.6	<i>Heat retention</i>	21
4.7.7	<i>Exhaust heat recovery (AirConcept)</i>	21
4.7.8	<i>Wastewater heat recovery</i>	21
4.8	Automatic standard functions	21
4.8.1	<i>Eco mode</i>	21
4.8.2	<i>Forced drainage</i>	22
5	TECHNICAL DATA.....	22
5.1	EC/EU declaration of conformity	22
6	ASSEMBLY	22
6.1	Prerequisites for assembly	23
6.1.1	<i>Checking the condition at delivery</i>	23
6.1.2	<i>Requirements for the installation area</i>	23

6.1.3	<i>Requirements for the waste water connection</i>	23
6.1.4	<i>Requirements for the fresh water connection</i>	23
6.1.5	<i>Requirements to the electrical connection</i>	25
6.2	Transport	27
6.3	Perform assembly	27
7	COMMISSIONING	28
7.1	Check prerequisites for commissioning	29
7.2	Perform commissioning	29
8	OPERATION/USE.....	30
8.1	Glass control panel	30
8.2	Prepare dishwasher	31
8.2.1	<i>Putting the machine into operation</i>	33
8.3	Washing	33
8.3.1	<i>Putting away washware</i>	33
8.3.2	<i>Select wash programme</i>	34
8.3.3	<i>Start wash cycle</i>	38
8.3.4	<i>Operation using wash key</i>	38
8.3.5	<i>Touch operation</i>	39
8.3.6	<i>Rack detection (Intelli-Start) (option)</i>	40
8.3.7	<i>Emptying the washware</i>	41
8.3.8	<i>Closing the hood without triggering automatic wash start</i>	42
8.3.9	<i>Prevent rinsing start on machines without automatic hood system</i>	42
8.4	Malfunctions	42
8.4.1	<i>Messages</i>	43
8.4.2	<i>Restricted operation</i>	45
8.5	Shutting down the dishwasher	46
8.6	Change authorisation level	46
8.7	Reset the counter	48
8.8	Adjust dosing quantity	49
8.9	Activate/deactivate Bluetooth interface	49
8.10	Private Label 2.0	50
8.10.1	<i>Setting waiting time for Private Label</i>	51
8.11	Setting the waiting time for dimming the display brightness	52
8.12	Ventilating the pipes	52
8.13	Perform a manual water change	52
8.14	Replace canister	53
9	MAINTENANCE AND CLEANING	53
9.1	Maintenance	54
9.2	Maintenance table	55
9.3	Daily cleaning	57
9.4	Cleaning the stainless steel surfaces	58
9.5	De-scaling	58
9.6	Spare parts	59
10	DISMANTLING AND DISPOSAL	59
10.1	Disposal of packaging materials	59
10.2	Dismantling and disposal of the old device	60

11 ABBREVIATIONS.....	60
12 INDEX	61
13 NOTES.....	63

1 Notes on the operating instructions

Dear customer,

We are delighted about the confidence you have shown in our products.

It is very important to us that you should enjoy using and benefit from MEIKO products and that they should make your work easier.

The operating instructions help familiarise the operator of this dishwashing machine with its installation, modes of operation, use, safety instructions and servicing.

The operating instructions are an integral part of the dishwashing machine and must be passed on to all subsequent owners or users.

Please read these operating instructions through carefully before use. Please also take note of any additional operating instructions for accessories and integrated third party components.

Only through understanding these operating instructions can errors be avoided and trouble-free operation of the dishwasher guaranteed. By paying attention to the operating instructions, hazards can be avoided, repair and breakdown costs reduced and the reliability and durability of the dishwashing machine can be increased.

Retain these operating instructions for the entire lifetime of the dishwashing machine. The storage location must be protected against moisture. Please store the operating instructions in a readily accessible location close to the dishwashing machine.

Ensure that all persons who work with or on the dishwashing machine have read and understood the operating instructions.

The operating instructions must be available in the local language for each EU country. If this is not the case, the washing machine must not be commissioned.

The original operating instructions in German and all operating instructions in all languages for EU countries can be downloaded from the following address: <https://partnernet.meiko-global.com>

The entire technical documentation are available free of charge. Additional copies are available for a nominal fee.

Notes on use of the operating instructions:

- A bullet point (•) designates an action step.
- Numerals (1.) designate several action steps that must be executed in the specified sequence.
- Position numbers in the text that refer to position numbers in figures are shown in parentheses:
(1) Position number 1 in the illustration
- The text is always below the figure and refers to it until a new image follows.

1.1 Product identification

These operating instructions apply to the following machine types:

Hood type dishwashing machine **M-iClean H**

Name	M	i	Clean	H
Meaning	MEIKO	Intelligent	Clean	Hood

1.2 Delivery contents

The delivery contents include:

- 1x hood type dishwashing machine: M-iClean H
- Matching racks for glassware, crockery and containers, depending on machine model
- Connecting hoses for fresh water and waste water
- Key to change pre-filter (only with GiO option)
- Documentation

1.3 Related documents

In addition to these operating instructions, there are other documents that are available depending on the authorisation:

Operator (included in delivery contents)	Authorised service technician
EC/EU declaration of conformity	Dimension sheet
Short operating instructions	Installation instructions
Wiring diagram	Installation instructions for optional components (e.g. GiO module separately)
	External dosing
	Service instructions

2 Liability and warranty

All of MEIKO's obligations arise from the relevant purchase contract, which also contains the entire and only valid guarantee provisions. These contractual guarantee provisions shall be neither extended nor restricted as a result of any explanations given in the instructions.

If you follow the instructions in this operating manual carefully, your dishwashing machine will always give you total satisfaction and will have a long service life.

The delivered system corresponds to the state of technology and safety regulations valid at the time of production/delivery.

The information, data and notes specified in the operating instructions correspond to the latest version at the time of printing. No claims for already delivered systems may be asserted based on these statements, illustrations and descriptions.

Claims must be reported to the manufacturer immediately after determination of the defect or error. Liability claims for personal injury or material damage as well as for operational problems are excluded if they are due to one or more of the following causes:

- Unintended use.
- Improper installation, commissioning, operation and maintenance.
- Operation of the machine or system with defective safety devices or improperly attached or non-functioning safety and protective devices.
- Noncompliance with the notes in the operating instructions regarding transport, storage, mounting, commissioning, operation and maintenance.
- Unauthorised design changes or settings on the machine or system beyond the intended purpose.
- Improper monitoring of parts subject to wear.

- Use of wear and replacement parts that are not from the manufacturer.
- Improperly performed repairs, inspections or maintenance.
- Catastrophes due to human-induced events or force majeure.

3 Safety

3.1 Symbol explanation

3.1.1 Notes in the instructions

Warnings

Danger

Short description of the danger:

The signal word **DANGER** designates an immediately threatening danger.
Failure to observe this leads to very serious injuries or death

Warning

Short description of the danger:

The signal word **WARNING** designates a possible danger.
Failure to observe this can lead to very serious injuries or death.

Beware

Short description of the danger:

The signal word **BEWARE** designates a possible danger.
Failure to observe this can lead to minor to medium injuries.

Application information

Caution

Short description:

The signal word **Caution** designates a possible danger.
Failure to observe this can lead to damage to the machine or system.





Note

The signal word **Note** designates further information on the machine / system or its application.

3.1.2 Safety symbols in the instructions

The following note and danger symbols are used both in the document and on the machine. Observe these symbols and signs on the machine to avoid personal injury and material damage!

The symbols have the following meanings:

Symbol	Meaning
	Warning of hazardous areas
	Warning of dangerous electric voltage
	Warning of the danger of hand injuries Caution, keep hands away from parts that bear this warning symbol. The danger exists that hands can be crushed, pulled in or otherwise injured.
	Warning of hot surfaces and liquids
	Warning of the machine falling over
	Warning of environmental damage
	Do not spray with water
	No drinking water
	Access prohibited for persons with pacemakers
	Eye protection must be used or protective glasses must be worn
	Hand protection must be worn
	Read the operating instructions
	Disconnect before servicing or repair
	Potential equalisation connection

3.2 Requirements for the personnel

Commissioning, instructions, repairs, maintenance, assembly and installation of or on MEIKO machines must only be carried out/authorised by MEIKO-authorized service partners.

During operation it must be ensured that:

- Only adequately trained and instructed personnel are allowed to work on the machine.
- Personnel responsibilities for operation, maintenance and repairs must be clearly defined.
- Any personnel undergoing training are only allowed to work on the machine under the supervision of an experienced person.

The required qualifications for performing specific work at the machine are determined by MEIKO.

Activity	Persons	Trained operating staff	MEIKO authorised company tradesman	MEIKO authorised service technician
Installation/assembly				✓
Commissioning				✓
Operation, use		✓	✓	✓
Cleaning		✓	✓	✓
Check safety devices			✓	✓
Troubleshooting		✓	✓	✓
Troubleshooting, mechanical		✓	✓	✓
Troubleshooting, electrical			✓*	✓
Maintenance			✓	✓
Repairs			✓	✓

* with training as an electrician



Note

The instructions must be acknowledged in writing.

Qualified staff, as defined by the operating Instructions, are persons:

- over 14 years of age,
- due to their training, experience and instruction are able to perform the required activities,
- are authorised to perform the required activities by the person responsible for safety of the machine,
- who have been trained in first aid and in the on-site rescue arrangements,
- have read and understood the operating instructions and corresponding safety instructions and will follow them.

3.3 Residual risks

Phase	Activity	Nature of the hazard	Avoidance measure
Transport and assembly	Loading and unloading with forklift truck	Crushing/impact	<ul style="list-style-type: none"> • Load-bearing capacity of the forklift truck must be adequate for the weight of the machine • Please note the machine's centre of gravity • Secure to prevent slipping
	Deposit at the installation location	Crushing/impact	<ul style="list-style-type: none"> • Ensure that the ground beneath is capable of taking the load • Ensure that the machine cannot tip

Phase	Activity	Nature of the hazard	Avoidance measure
	Incorporate into customer table system	Shearing	<ul style="list-style-type: none"> Ensure that no shear points are created between the hood and the table
	Position freestanding machine	Crushing	<ul style="list-style-type: none"> Ensure that the freestanding machine is secured to prevent it from tipping backwards
	Install electrical connections	Electric shock	<ul style="list-style-type: none"> Adhere to the accident prevention regulations
	Install separate GiO MODULE (optional)	Trips/falls/crushing	<ul style="list-style-type: none"> We recommend fastening the GiO MODULE to the wall/table/machine Mount freestanding module using solid base If necessary, run module at 90 degrees (lying)
Commissioning	Fill with detergent/rinse aid	Eye injury/health risks	<ul style="list-style-type: none"> Wear safety eyewear/gloves Avoid contact with skin and eyes
	Activities in the machine	Hand injuries on sharp edges	<ul style="list-style-type: none"> Wear protective gloves
Operation	Filling/heating	Scalding	<ul style="list-style-type: none"> Do not set machine in operation without tank cover sieve
	Programme is running	Scalding on inappropriate opening of hood	<ul style="list-style-type: none"> Do not open hood during cycle
		Machine catching fire due to overload or blockage of pump motors	<ul style="list-style-type: none"> Always use fine/coarse sieve when running the machine to keep out foreign bodies Pre-wash washware
	Loading and unloading the machine	Trapping of hand	<ul style="list-style-type: none"> To close the hood, use the handle designated for this purpose
		Broken crockery causing cuts/severing	<ul style="list-style-type: none"> Wash/clean washware in the specially designed rack in the machine Place small items in the appropriate rack inserts Washware must not come into contact with rotating parts of the machine
		Risk of snagging with loose clothing or items of jewellery	<ul style="list-style-type: none"> Wear suitable work clothing and sturdy shoes Do not wear rings, necklaces or other pieces of jewellery
		Slipping	<ul style="list-style-type: none"> Use non-slip floor coverings
		Scalding/burning	<ul style="list-style-type: none"> If necessary, allow washware to cool down If necessary, allow machine components to cool down before touching Do not remove tank cover sieve while machine is in operation Protective gloves recommended Only ever use the hood handle to open/close the hood
	Other activities	Swallowing of water in the wash chamber	<ul style="list-style-type: none"> Do not use the water in the wash chamber for food preparation or drink it
	Normal operation	Substandard wash performance due to failure of dosing units	<ul style="list-style-type: none"> Monitor wash performance If appropriate, repeat the programme
Refilling detergent/rinse aid	Eye injury/health risks	<ul style="list-style-type: none"> Wear safety eyewear/gloves Avoid contact with skin and eyes 	
Maintenance and cleaning	Any maintenance work	Electric shock	<ul style="list-style-type: none"> Before opening the housing parts, ensure the mains switch has been disconnected and secured so that it cannot be turned on again
	Cleaning or maintenance	Scalding/burning	<ul style="list-style-type: none"> Allow machine components to cool down before touching Wear protective gloves
		Hand injuries on sharp edges	<ul style="list-style-type: none"> Wear protective gloves

Phase	Activity	Nature of the hazard	Avoidance measure
	Cleaning	Poisoning	<ul style="list-style-type: none"> Do not use aggressive cleaning or scouring agents Only use descaling products suitable for commercial machines Wear protective gloves
	GiO MODULE: replace filter cartridge	Water escaping	<ul style="list-style-type: none"> Provide suitable vessel (e.g. base drip tray)
Dismantling and disposal	Dismantling	Eye injury/health risks	<ul style="list-style-type: none"> Wear safety eyewear/gloves Avoid contact with skin and eyes If necessary, clean hoses, dosing system and machine parts with fresh water
	Loading and unloading with forklift truck	Crushing/impact	<ul style="list-style-type: none"> Load-bearing capacity of the forklift truck must be adequate for the weight of the machine Please note the machine's centre of gravity Secure to prevent slipping

3.4 Intended use

The dishwashing machine must only be used in accordance with its intended purpose and as per these operating instructions. The dishwashing machine is intended exclusively for commercial use.

The dishwashing machine is designed for cleaning dishes, cutlery, glassware, kitchen utensils, baking trays and containers.

The washware must be suitable for dishwashing machines. If there is any doubt, a consultation (size, version, basic suitability for dishwashing machine, etc) can be carried out with MEIKO to confirm suitability (info@meiko-global.com).

The following applications are expressly not intended:

- Processing hazardous substances in the machine (health hazards, in particular toxic, highly or extremely flammable and explosive substances).
- Operating the machine in an explosive environment.

3.5 Foreseeable misuse

The dishwashing machine must not be used for:

- Washing kitchen utensils with electronic components
- Cleaning textiles, oven cloths or steel sponges
- Washing utensils made of iron or utensils that must not come into contact with foodstuffs (e.g. ashtrays, candlesticks, etc)
- Cleaning living creatures
- Washing food for subsequent consumption
- Preparing foodstuffs in the machine
- Taking wash fluid to prepare food or for drinking
- Washing support grids of cooking hobs / gas hobs
- Filling the machine from an external source (e.g. shower)
- Introducing service water into the local waste water system
- Standing or sitting on machine parts (e.g.: door)
- Washing parts made of wood
- Washing plastic parts that are not heat and alkali-stable
- Washing parts made of aluminium (such as pots, containers or trays only with a suitable detergent to avoid black discolouration)

3.6 Fundamental safety and accident prevention regulations



Note

The following safety instructions aim to protect operating personnel as well as third parties and the dishwashing machine itself.

Please take note of the information in these instructions and the signs on the dishwashing machine.

However, safety can only be guaranteed during operation if all necessary measures are taken.

The operator of the machine has an obligation of care to ensure that these measures are planned for and also to check that they are correctly implemented.

The operator must ensure in particular that:

- The dishwashing machine is only used in accordance with its intended purpose. In the event of the machine being used or operated contrary to this, damage or risks may arise.
- In order to guarantee functionality and safety, only original spare parts supplied by the manufacturer may be used.
- The safety of the dishwashing machine is not impaired by the subsequent installation of a dosage system.
- Only appropriately qualified and authorised personnel operate, maintain and repair the dishwashing machine.
- No one sits or stands on the open door.
- Staff are regularly trained in all questions relating to occupational safety and environmental protection and are familiar with the operating instructions and, in particular, the safety information that they contain.
- The area around the machine is assessed with reference to the risk to other people, e.g. children; people with physical, sensory or mental impairments; people lacking in knowledge or experience. In case of doubt, special optional initiation functions other than conscious, intentional operation (i.e. operation from the screen) are to be deactivated.
- The dishwashing machine is only operated in perfect, functional condition, all protection devices and covers are installed.
- The safety and switching equipment is regularly tested to ensure it is functioning correctly.
- Dishwashers accessible from behind may only be operated with a rear cover.
- The required personal protective equipment is made available to and worn by maintenance and repair personnel.
- A functional test on all dishwashing machine safety systems is carried out at every regular maintenance appointment.
- None of the safety and warning notices affixed to the dishwashing machine itself are removed and all are legible.
- Upkeep (maintenance and inspection) is carried out on optional vendor parts according to the requirements in the corresponding instructions.
- Following installation, commissioning and handing over of the dishwashing machine to the customer/operator, no modifications are made (e.g. electrical or mechanical machine components).
- Equipment for optimising energy consumption must not be used to lower the required operating temperatures, as set out in the standards DIN 10510, 10511 and 10512. If equipment for optimising energy consumption is nevertheless installed, MEIKO does not accept any responsibility for a possible reduction in the quality of the wash and hygiene.

Information on operating the dishwashing machine:

- Only operate the dishwashing machine under the supervision of trained personnel.
- Do not use the dishwashing machine if you are unsure about its operation.
- Always close all doors and flaps.

- Wear suitable work clothing.
- When working on the dishwashing machine, wear appropriate protective gloves.
- Allow machine components and washware to cool down before touching.
- At the end of operation:
 - Switch off the dishwashing machine at the on-site mains disconnection device. This is located in the electricity supply pipe for the machine.
 - Close the on-site stop valve in the fresh water supply line.

Information on use of detergent and rinse aid:

- Only use detergents and rinse aid suitable for commercial dishwashing machines.
- Acquire information from the manufacturers of these products.

Detergent and rinse aid may contain hazardous substances. The wash water used during operation contains chemicals.

- Never drink the wash water.
- Contact a doctor immediately if wash water is swallowed.
- Pay attention to the manufacturers' hazard warnings on the original canisters and safety data sheets.
- When handling chemicals, wear appropriate protective gloves and safety eye-wear.
- Do not confuse detergent and rinse aid.
- Ensure that the suction connections for the dishwashing machine are correctly connected to the canisters.

Information on the use of descaling agents

Residue from descaling agents can cause damage to the plastic components and sealing materials in the machine.

- Acquire information from the manufacturers of these products.
- Please observe the manufacturer's hazard warnings.
- Thoroughly remove any residue after use.

Information on cleaning the machine

Foam can cause malfunctions in the dishwashing machine and a poor washing result.

- Do not use a foaming manual dishwashing detergent for precleaning or for cleaning the machine.
- Allow machine components and washware to cool down before touching.

Information on cleaning the surrounding area

When cleaning the surrounding area, the machine can be damaged by aggressive external influences (steams, detergents) or the ingress of water.

- Do not use aggressive detergents (e.g. aggressive tile cleaner).
- If installed at ground level, never allow the surrounding area to flood.

Notices on electrics and electronics

There is a danger to life if exposed parts and damaged supply lines under electrical voltage are touched.

- Please take note of the warning information in these instructions and the signs on the dishwashing machine.
- Whenever you are working on electrical components in the machine, ensure that electrical connections are physically secure.
- Whenever you are working on electrical components in the machine, check wires and cables for any potential damage and replace, if necessary.

Incorrect cleaning can cause damage to the electronics.

- The dishwashing machine, switch cabinets and other electrical components must never be sprayed with a hose or high pressure cleaner.
- Ensure that no water can enter the machine by accident.

Notice on non-ionising radiation



The dishwasher does not specifically generate non-ionising radiation. For technical reasons, only the electric appliances emit non-ionizing radiation.

In the immediate vicinity of the dishwashing machine, the influence of active implants (e.g. cardiac pacemakers, defibrillators) can be ruled out with a high degree of probability.

3.7 What to do in the event of an emergency



- In dangerous situations, disconnect from the power supply using the locally available mains isolator.

4 Product description

4.1 Functional description

The M-iClean H is a hood type dishwashing machine with a square basket.

The dishwasher has one wash and one final rinse cycle.

A temperature regulator maintains the set wash temperature of between 58-60 °C. A rotary pump circulates the water from the wash tank into the wash nozzles. The water jets hit the wash ware from different directions. This ensures uniform washing results.

The wash cycle is followed by a fresh water final rinse. The items being washed are rinsed with hot fresh water at 80-83 °C (65 °C for the glass programme) via a separate nozzle system. This heats up the wash ware for the following drying process.

At the same time, the final rinse water is used to regenerate the rinse water; this reduces the degree of soiling of the rinse water.

4.2 Overview illustration

Exterior view

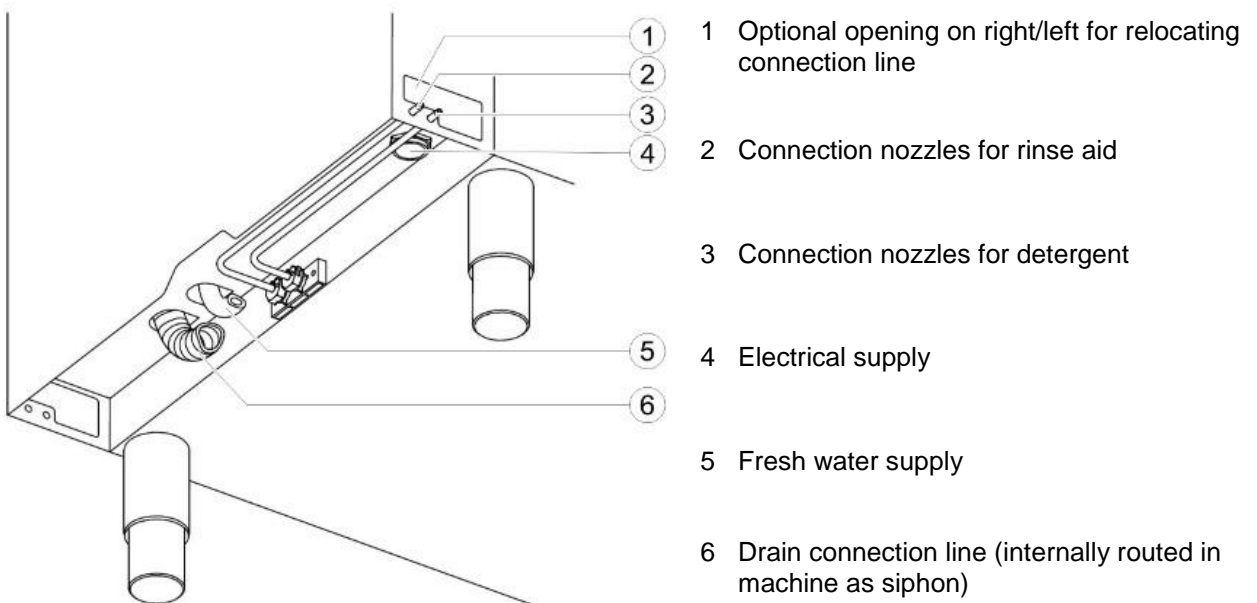
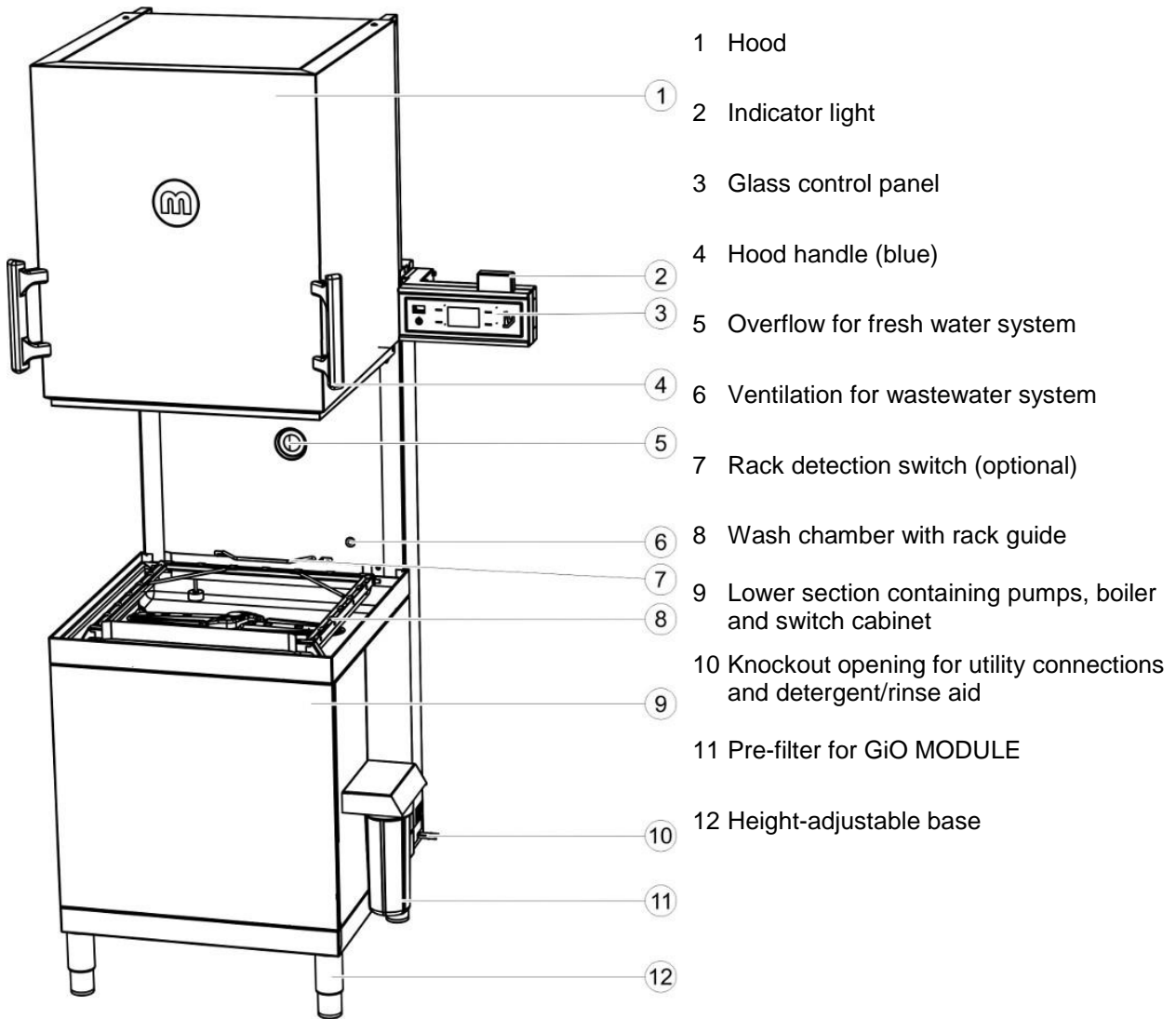

Interior view

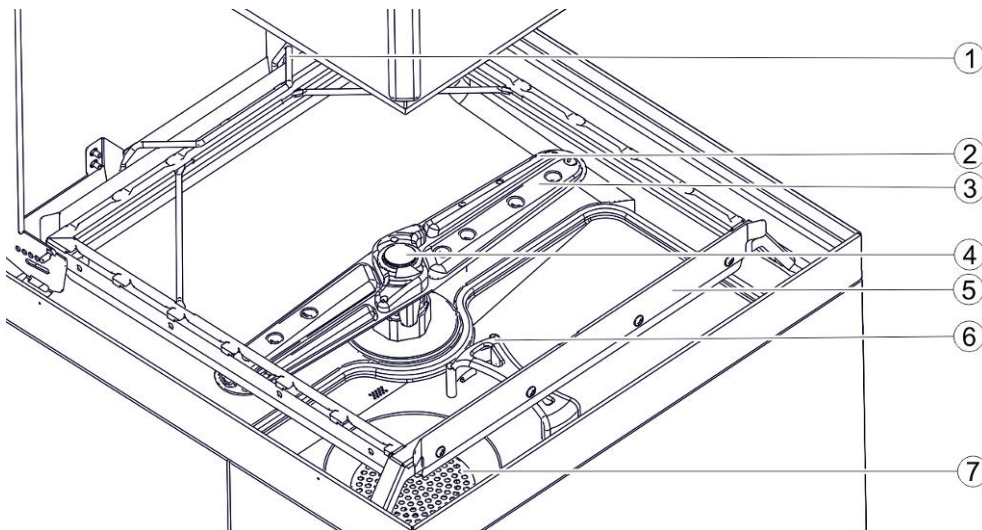

- | | |
|------------------------------------|---------------------------------|
| 1 Rack detection switch (optional) | 2 Wash arm (final rinse system) |
| 3 Wash arm (cleaning system) | 4 Retaining screw for wash arm |
| 5 Rack guide | 6 Sieve cover |
| 7 Suction strainer | |

4.3 Type label

The rating plate on the M-iClean H is located on the left or right-hand side in the lower rear section of the machine. Further rating plates are located on the switch cabinet behind the front panel and on the display.

The following information can be found on the M-iClean H's rating plate:



Machine	Dishwasher			
Model				
Serial No.				
Connection	○	○	●	○
Date				
Voltage	3N/PE 400 V			
Frequency [Hz]	50	50	50	50
Rated Power [kW]	9,8	9,9	16,8	16,9
Rated Current [A]	16,3	16,3	27,4	28,4
IP	X5			
Baujahr	2017			



- 1 Name and address of manufacturer
- 2 Machine type
- 3 Model name
- 4 Serial number
- 5 Electrical connection variant (marked ●)
- 6 Change date (if required)
- 7 Voltage
- 8 Frequency
- 9 Rated power
- 10 Rated current
- 11 IP protection rating
- 12 Year of manufacture
- 13 CE mark
- 14 IP protection rating



Notice

The M-iClean H can be connected to the power provided a power supply is locally available. The connection variant currently available is labelled ● under (5). A (MEIKO authorised) electrician can attach a different connection variant.

4.4 Indicator light

The indicator light shows different colours depending on the operating mode.



- Blue: machine is ready for operation



- Green: a wash cycle is running



- Red: there is a status notification

4.5 Blue operating concept

The parts of the dishwasher that must be touched by the operator in operation and in daily use are blue. And so after a short briefing, operators know intuitively that they have to remove and clean the wash system, tank cover sieve and filter, for example.



- 1 Blue handle on tank cover sieve
- 2 Blue handle on wash arm
- 3 Blue filter

4.6 Detergent and rinse aid



⚠ Warning

Risk of injury from contact with chemicals

- Observe the safety data sheets and dosing recommendations of the chemical manufacturers.
- Use eye protection.
- Wear protective gloves.
- Do not mix different chemical products.

⚠ Caution

- Only use products that are suitable and approved for commercial dishwashers. MEIKO recommends MEIKO ACTIVE detergent and rinse aid. MEIKO ACTIVE products are optimally adapted to MEIKO dishwashing machines.
- Do not mix different cleaning products.

The dishwashing machine is equipped by default with dosing units for dosing liquid detergent/rinse aid. Manual dosing with powder cleaner is not intended.

Optionally, the dishwashing machine can be equipped with or prepared for an external dosing system. In this case, further information can be found on the wiring diagram and in the External dosing document.

4.6.1 Detergent

Detergents are alkaline (pH value should be > 7) and are needed to dissolve soiling from the washware. The standard setting is 2 ml of detergent per litre of tank water. If necessary, the concentration can be adjusted depending on the water quality, washware and degree of soiling. This setting is made during commissioning by an service technician authorised by MEIKO or the chemical supplier.

Change dosing quantity, see page 49.

4.6.2 Rinse aid

Rinse aids are acidic (pH value should be between 2 and 7) and accelerate the drying of the washware by reducing the surface tension of the water so that it can run off the washware quickly.

The correct dosage is achieved when the water drips evenly from the washware and depends on the available water quality on-site. This setting is made during commissioning by an service technician authorised by MEIKO or the chemical supplier.

Change dosing quantity, see page 49.

4.6.3 Dosing equipment

The components of the dosing units are subject to high demands and must therefore be regularly maintained and, if necessary, replaced in accordance with the maintenance specification.

The service life of the dosing units and other components of the dishwashing machine depends on the use of suitable chemical products. MEIKO recommends MEIKO ACTIVE detergent and rinse aid. MEIKO ACTIVE products are optimally adapted to the dishwashing machine.

4.6.4 Suction lances

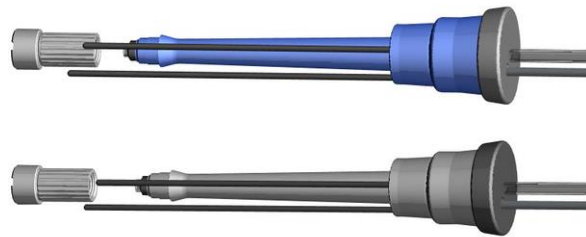

Suction lances with level monitoring for rinse aid (blue) and detergent (grey)

Suction lances ensure that the liquid chemical product is sucked in correctly. Suction lances are inserted vertically into the canisters and are optionally equipped with level monitoring. When the canister is running low, a message will appear on the machine display.

4.6.5 Change of products

⚠ Caution

When changing the detergent product (even to a product from the same manufacturer), crystallisation may occur, which can lead to failure of the dosing system.

- When changing the detergent product, flush the dosing system with warm water.

Procedure for changing the detergent product:

1. Provide a suitable container with warm water and insert the suction lance.
2. Thoroughly flush the dosing system several times by **venting the lines**, see page 52.
3. Wipe the suction lance and put it into the canister with the other detergent product.
4. Refill the dosing system by **venting the lines**.

For dishwashers with an internal reservoir, have the system flushed by a service technician authorised by MEIKO.

4.7 Options

4.7.1 GiO-MODULE

The module works according to the principle of reverse osmosis. Drinking water is pressed by a pump through a semi-permeable membrane. The membrane lets only water molecules through. The hardness components and salts (lime scale, etc.) contained in the water are held back. The clean water (permeate) is brought to the dishwashing machine; the materials held back (concentrate) are brought to the drain.

4.7.2 Automatic hood system

The hood is fitted with an electric motor, removing the need for physical effort when opening and closing.

Features:

- Closes hood when wash key is pressed
- Closes hood with optional **basket detection**
- Opens and closes hood when hood handle is tapped
- Opens hood when cycle is finished (setting)

4.7.3 Rack detection (Intelli-Start) (option)

Basket detection/Intellistart is an additional function available with the **automatic hood system** option. When the basket is pushed into the machine, the hood closes after 3 seconds and the chosen wash cycle starts automatically, see page 40.

4.7.4 PowerWash

Electronic regulation of wash performance to be optimally adjusted to the washware and degree of soiling:

- 3 pressure levels, see page 36
- Soft start
- Integrated into the following models: HM-PW, HL, HXL-PW

4.7.5 Disinfection control

Caution

Glass corrosion and loss of decorations due to high water temperatures and long wash cycle times

- Make sure that the dishes and glassware used are suitable for the high stress placed on them.

MEIKO offers two types of machine with thermal disinfection for institutions with additional hygiene requirements. Both versions have greater heating performance in the wash tank than standard machines.

A₀ control

The term **A₀** refers to a way of measuring how microorganisms are eliminated by moist heat disinfection methods. By using a moist heat disinfection method, it is expected that a specific temperature over a period of time has the effect of eliminating a predictable number of microorganisms with a particular resistance.

The standard setting for a dishwasher with **A₀** – control is the hygiene value **A₀ 30**:

- The tank temperature during washing is up to 74° C.
- For tank temperatures of 65° C or higher, each tank temperature is assigned a factor.
- Using the measured tank temperature, a value is determined and added every second until the hygiene value **A₀ 30** is reached.
- The rinsing process runs until the end of the programme cycle time, but at least until the temperature value is reached. After this comes a pause for draining and the final rinse.

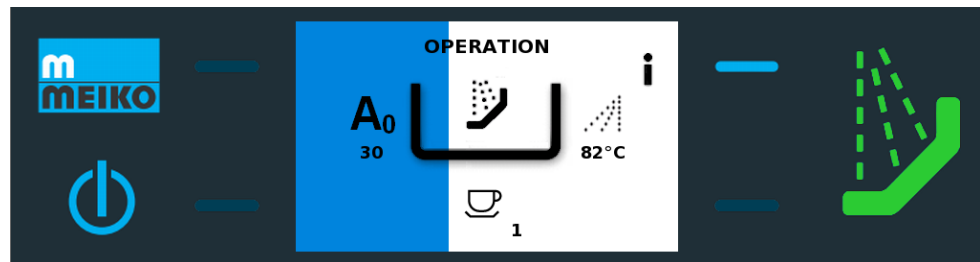

The display shows the current A₀ value.

Thermolabel control

In a way which is similar to A₀ control, machines with Thermolabel control have a disinfection process which uses moist heat. The dishwasher heats the rinse water to a higher temperature in order to eliminate germs. The efficacy of the disinfection can be tested using a measurement strip, the Thermolabel. The measurement strip changes colour after 4 seconds at 71 °C for a wash item.

- During washing, the tank temperature is heated up to 71° C and maintained at that temperature.
- The rinsing process runs until the end of the programme cycle time, but at least until the temperature value is reached. After this comes a pause for draining and the final rinse.
- Washing at high temperatures and long spells in the wash tank can lead to glass corrosion and premature wear to decoration.

Thermal disinfection - control

Thermal disinfection works according to the same principle as Thermolabel control, but other requirements apply:

- The disinfection temperature is $\geq 80^{\circ}$ C, which must be maintained on the washware for ≥ 30 s.
- During washing, the tank temperature is heated up to 76° C, and the final rinse temperature is 88 °C.
- The rinsing process runs until the end of the programme cycle time, but at least until the temperature value and specified stop time are reached. After this comes a pause for draining, final rinse and a subsequent application time.

Thermolabel and thermal disinfection control offer a disinfection effect that exceeds the standard, such as for hospitals, care homes, requirements according to the ÖGSV Guideline.

4.7.6 Heat retention

The heat retention setting closes the back of the hood when the hood is open.

- Loss of steam into the surrounding area at the end of the cycle is reduced.
- Saves energy by retaining steam.

Available:

- ONLY in conjunction with automatic hood system
- NOT in conjunction with AirConcept

4.7.7 Exhaust heat recovery (AirConcept)

The exhaust heat recovery system is installed on the back of the hood:

- Loss of steam into the surrounding area is reduced.
- Saves energy by targeted suction of hot steam through a fresh water heat exchanger.
- Heated water is available for the next wash cycle.

Available:

- NOT in conjunction with warm water
- NOT in conjunction with heat retention

4.7.8 Wastewater heat recovery

Hot wastewater is pumped through a metal pipe into a stainless steel heat exchanger:

- The fresh water in the metal chamber of the heat exchanger is heated.
- Saves energy because the boiler can heat less.

4.8 Automatic standard functions

4.8.1 Eco mode



During periods of inactivity (pauses), the machine displays a leaf symbol to show that energy is being saved and components protected.

	Active following	Description
ECO MODE I	60 sec	Rinse water temperature reduced.
ECO MODE II	180 min	Rinse and wash water temperatures reduced. Water level in wash tank adjusted to optimum level.
ECO MODE III	8 h	Boiler is drained. Wash water temperature is reduced. Water level in wash tank adjusted to optimum level.
ECO MODE IV	14 h	Machine is drained and shut down.

4.8.2 Forced drainage

If the wash tank and boiler have been full for 24 hours, they will be force drained. The water in the wash tank and boiler is pumped out.

Forced drainage takes place depending on operational status:

- **MACHINE OFF:** when machine is switched on
- **ECO MODE:** either after 24 hours or upon start of Eco mode III or IV, .
- As soon as the door or hood is closed for the first time after 24 hours have passed.

5 Technical data

MEIKO has created a dimensional drawing that shows machine dimensions as well as connection and consumption values.

Further data should be taken from the MEIKO dimensional drawing.

Machine weight

Versions	Machine
M-iClean HM	145 kg
M-iClean HL	162 kg
M-iClean HXL	230 kg

Noise emissions

Work place noise level LpA ≤ 70 dB (A).

5.1 EC/EU declaration of conformity

See separate EC-/EU-Declaration of Conformity.

6 Assembly

Warning

Danger of injury from entering a danger zone

Unauthorised persons might be in or enter the danger zone during transport, assembly, commissioning, maintenance and repair work. This can lead to injuries.

- Only permit qualified persons to perform work at the machine.
- Remove unauthorised persons from the danger zone.
- Cordon off danger zone and signpost it for third parties.
- Never remove or disable safety devices on the machine.
- Always wear cut-resistant protective gloves when removing housing parts and when working inside the machine!



6.1 Prerequisites for assembly

6.1.1 Checking the condition at delivery

- Check that the delivery is complete immediately after receiving it by comparing it with MEIKO's order confirmation and/or the delivery note.
- If applicable, submit a claim for any missing parts immediately to the freight forwarder and notify MEIKO.
- Check the machine for transportation damage.



Note

If there is any suspicion of transportation damage, the shipping company and MEIKO must be informed immediately in writing. Photograph any damaged parts and send the pictures to MEIKO.

6.1.2 Requirements for the installation area

The dishwashing machine is only frost-proof in as-delivered state or if equipped with special features (optional: frost removal).

Installation of the dishwashing machine in an area where the ambient temperature is below 0° C can result in damage to the internal water circuit components (e.g. pump, solenoid valve, boiler, etc.).

- Ensure that the storage and installation locations are always frost free.

There is a danger of slipping in the working area due to the use of water.

- After assembly, put in place non-slip floor coverings in the working area based on the general/location-specific safety regulations.

6.1.3 Requirements for the waste water connection

A waste water pump is integrated into the drain pump.

- Connect the drainage hose to the locally available waste water pipe.

– For Australia only:

The drainage hose needs to have a watertight connection to a waste fitting complying with AS 1589 AS 2887, a sanitary plumbing pipe or fitting complying with AS/NZS 1260.

- Depending on the dishwasher application, a grease trap may be included, based on the general/location-specific regulations.
- For dishwashers with GiO MODULE, the maximum drain height must be considered (see dimensional drawing).

6.1.4 Requirements for the fresh water connection



Note

Where the water conductivity is $\sigma < 100 \mu\text{S}/\text{cm}$, the stainless steel variant of Air-Concept must be used. This is the case when using a reverse osmosis (GiO) or demineralisation system, for example.

For Australia only:

All work carried out must be in accordance with AS/NZS 3500.1!

Fresh water connections and their components must be carried out in accordance with local regulations, e.g. EN 1717/DIN 1988-100. The fresh water must be of the same quality as drinking water in microbiological terms. This also applies to processed water.

The basic model of the dishwashing machine features an air gap (type AA or AB as per EN 1717 or EN 61770). In the case of SVGW (Switzerland) and other countries, a type EA safety device is also required in front of the connecting hose, depending on the machine version. Installation components and materials must be suitable and permitted in accordance with local regulations. A solenoid valve is integrated into the dishwashing machine's fresh water line. This, together with the leakage detector in the floor tray in the frame, ensures that the fresh water inlet within the machine is shut off in the event of a leak.

Pressure range of the fresh water supply flow pressure upstream of the solenoid valve:

- Machines with no GiO MODULE:
0.6 – 5 bar (60–500 kPa)
- Machines with GiO MODULE or ActiveClean water softener:
1 – 5 bar (100 – 500 kPa)

Maximum pressure

- The maximum pressure of 5 bar (500 kPa) must not be exceeded.

Measures to ensure correct water pressure:

- If the minimum flow pressure is too low, increase the pressure using a pressure booster pump.
- If the maximum pressure is exceeded, limit the pressure using a pressure regulator.

Other measures:

- Ensure that no rogue iron particles can enter the appliance via the mains fresh water connection. The same also applies for contamination by other metal particles (e.g. copper shavings). Corresponding instructions are contained in the installation drawing.
- A dirt trap must be fitted in the fresh water supply to protect the solenoid valve.
- After the dishwashing machine has been unused for an extended period of time, drain the connection line and rinse it before putting the machine back into operation.
- When replacing an old machine with a new one, make sure that the existing feed hose is exchanged for the new feed hose supplied with the machine.

Table: fresh water requirements for the operation of a reverse osmosis module

Designation	Value
Conductivity	70–1000 µS/cm
Water hardness	0–28 °dH
Feed water temperature	Min. 1 °C to max. 35 °C (cold water connection)
Minimum flow pressure	100 kPa (1 bar)
Maximum pressure	500 kPa (5 bar)
Free from particles	> 10 µm
Iron	< 0.1 mg/l
Manganese	< 0.04 mg/l
Chlorine (free chlorine)	< 0.1 mg/l (standard membrane)
Chlorine (free chlorine)	≥ 0.1 to ≤ 2.0 mg/l (more chlorine resistant membrane)
Potassium permanganate	< 10 mg/l
Silicic acid	< 10 mg/l

6.1.5 Requirements to the electrical connection



⚠ Warning

Danger to life from electric shock

Contact with live electrical parts can lead to serious injury or death.

- Work at or repairs to the electrical system must be conducted by a qualified electrician who complies with the electrotechnical rules.
- Disconnect the machine from the power supply before working on the electrical system. To do this, turn the local mains switch to **OFF** and ensure that it can't be switched back on again.

▶ Notice

The wiring diagram is located in the switch cabinet of the dishwashing machine. This must remain in the dishwashing machine!

The rating plates with the electrical connection values are located on the switch cabinet behind the front panel and on the display.

▶ Note

The machine complies with IEC 61000-3-12 provided that the short circuit power S_{SC} at the point where the customer's system connects to the public grid is greater than or equal to **1.4 MVA**. The installer or machine operator is responsible for ensuring that this machine is only connected at a connection point with an S_{SC} value greater than or equal to **1.4 MVA**. If necessary, they must consult the grid operator first.

MEIKO offers a line choke as a retrofit component for customers who do not have the necessary short circuit power at the connection point.

Other dangers

Danger of death by electric shock: contact with live electrical parts can lead to serious injury or death.

Who may connect it?

The dishwashing machine must be connected by a (MEIKO authorised) electrician in accordance with the locally applicable norms and regulations.

Local earth wire system

The electrical safety of this machine is only ensured if it is connected to a properly installed protective conductor system. It is very important to verify this fundamental safety feature. If in doubt, have the building wiring checked by an electrician.

Voltage and frequency

The machine may only be operated with the data provided on the descriptive plaque (see page 16).

Power cable/fixed connection:

Recommended connection with protective equipotential bonding

The machine and accessory appliances are intended for permanent connection to the locally available power supply and the locally available protective equipotential bonding and have been tested for the market accordingly.

A 5-pole terminal strip (L1, L2, L3, N, PE) must be used for connection to a three-phase current.

Electricity supply without a neutral wire (N): when connecting to three-phase current, use a 4-pole clamping strip (L1, L2, L3, PE).

Wire colours: live wire L1 = black/1, L2 = brown/2, L3 = grey/3, neutral wire N = blue/4, earth wire PE = green-yellow

Alternative connection without protective equipotential bonding

The operator can decide at his/her own discretion and under his/her own responsibility to connect the electricity supply using customer resources in collaboration with an electrician company:

1. Fixed connection without protective equipotential bonding
2. Plug connection according to EN 60309 (CEE plug connection)

Additional necessary measures for personal protection:

Machines with integrated frequency converters must have an RCD/FI circuit breaker (type B) max. 30 mA sensitive to all types of current installed rather than a residual current operated circuit breaker type A.



Note

Where discharge currents exceed 10 mA, the use of an RCD/FI is not recommended. False alarms restrict machine availability.

MEIKO expressly excludes any liability for damages caused by improper connection of the machine.

This includes any work in connection with services due to said connection, e.g. processing complaints or claims due to:

- Triggered RCD/FI
- Automatic shut-down of the supply when the earth wire for the consistency is lost (EN 60204-1 Chap. 8.2.8.c)

Local mains isolator

The power supply must be fused in accordance with the regulations and a lockable mains isolator provided in the local electrical installation.

If an unearthed neutral conductor (N) is used with three-phase current, the mains isolator must have 4 poles (with alternating current 2 poles).

If the neutral wire (N) is not earthed, you must use a 4-pole mains switch. Mains power cables must be oil-resistant, shielded, flexible cables no lighter than an H07RN-F cable.

Local fuse protection

The machine must be fused appropriately for the rated current shown on the descriptive plaque. The electrical connection must be fused as a separately fused circuit (final circuit). Take note of the connection variant.

Protective equipotential bonding

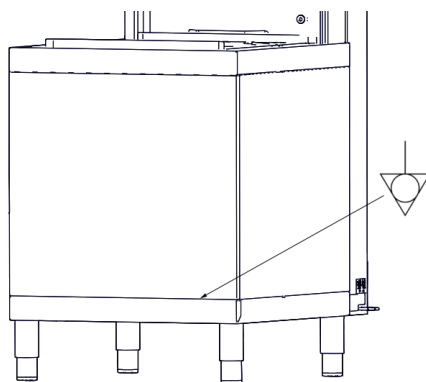

The screw for the potential equalisation is located behind the sheet of cladding on the front of the machine.

The potential equalisation connection must be carried out in accordance with the requirements of the local electricity supply companies and all applicable local regulations (in Germany VDE 0100 Part 540). Incorporate the machine and any conductive substructures and table systems into the local potential equalisation system.

Possibility to switch

The machine can be connected and switched to higher or lower power depending on the locally available power supply. This must be carried out by a (MEIKO authorised) electrician.

On delivery, the boiler heater is already wired to customer specifications and the connection variant is indicated on the descriptive plaque.

6.2 Transport

WARNING – danger of injury due to machine tipping

- Only qualified personnel may carry out transport works.
- Please note safety notices on the packaging.
- Always transport the machine on a wooden frame only.
- Wear protective gloves and safety shoes.

The packaging is specifically designed to allow the appliances to be moved safely and securely using a pallet jack or a sack truck. For safe transport, the dishwashing machine is supported by a special square-timber frame.



- Execute transport carefully.
- Open packaging using a suitable tool.
- Unpack the dishwashing machine only after transport is completed.

6.3 Perform assembly



Warning

Danger of injury due to machine tipping

If machine is freestanding and not secured, it could fall over and cause crushing.

- If machine is freestanding, it must be secured long term to prevent tipping.
- Wear protective gloves and safety shoes.

Beware

Improper fresh water connection

Backsiphonage of non drinking water into the water supply system

- Have the fresh water connected by a qualified professional and in accordance with local regulations.

Caution

Material damage due to ingress of pressurised media

- Shut off the fresh water supply at the main valve prior to installation works.
- Check that all lines are securely connected.

Caution

Material damage due to escaping steam

Small quantities of steam may escape through the dishwashing machine's hood area. It is possible that adjacent furniture may warp.

- Protect adjacent furniture from warping.
- If possible, avoid installing the machine in an area close to furniture susceptible to warping.



Note

When installing non-MEIKO tables on the hood type machine, ensure that no risks arise at the joint with the hood, such as danger of crushing or shearing.



Note

Assembly may be performed **only** by an authorised service technician.

Assembly must be carried out in accordance with the installation drawing.

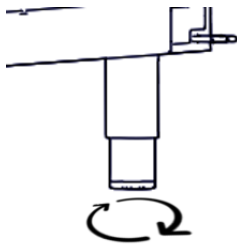

- Machine is intended for installation in front of a wall.
 - Otherwise, the machine must be secured against tipping backwards.
- Machine is intended for installation with table installation.
- Ensure the machine is level in both directions by using a spirit level.
- Compensate for an uneven floor by adjusting the feet.
- Table joints must be sealed with a detergent-resistant sealant (e.g. silicone).
- Check that the machine is stable.

Disposal of packaging materials, see page 59!

7 Commissioning

Warning

Danger of injury from entering a danger zone

Unauthorised persons might be in or enter the danger zone during transport, assembly, commissioning, maintenance and repair work. This can lead to injuries.



- Only permit qualified persons to perform work at the machine.
- Remove unauthorised persons from the danger zone.
- Cordon off danger zone and signpost it for third parties.
- Never remove or disable safety devices on the machine.
- Always wear cut-resistant protective gloves when removing housing parts and when working inside the machine!

7.1 Check prerequisites for commissioning

Caution

Material damage due to escaping steam

Small quantities of steam may escape through the dishwashing machine's hood area. It is possible that adjacent furniture may warp.

- Protect adjacent furniture from warping.
- If possible, avoid installing the machine in an area close to furniture susceptible to warping.

Prerequisites to be provided by the customer:

- Consistently frost free storage and installation area.
- Anti-slip floor coverings installed in the work area around the dishwashing machine.
- Electrical connection in accordance with the dimensional drawing.
- Fresh water connection in accordance with the dimensional drawing.
- Waste water connection in accordance with the dimensional drawing.

7.2 Perform commissioning



Note

Instruction and initial commissioning may be performed **only** by an authorised service technician! The operator must not use the dishwashing machine before completing training.

To avoid damage to the appliance or dangerous injuries during commissioning of the machine, please note the following points:

- Check supplier parts (e.g. external water processing devices or heating pumps). More detailed information can be found in the relevant operating instructions.
- Ensure that all tools and foreign parts are removed from the machine.
- Make sure that any escaped fluids have been removed.
- Before commissioning, activate all safety systems and door switches (on under-counter machines).
- Check all screw connections sit securely.
- For dishwashing machines with GiO Module, attention must be paid to the "Commissioning certificate for GiO Modules" and the instructions adhered to accordingly.







8 Operation/use



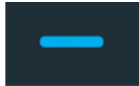





8.1 Glass control panel

The machine is equipped with an operation panel. This includes a total of 7 keys which are used to operate the machine. A display in the centre of the operation panel provides information about the machine's current operational status. In addition, depending on which of the 4 confirmation keys next to the display is pressed, further information and menus are displayed. Inactive confirmation keys are not illuminated.

The meaning of each of the keys and symbols is described below.



Button/symbol	Meaning
	On/off key Filling/heating on or machine off
	Confirmation key Meaning/function is shown on the display next to the relevant key
	Wash key Flashing blue: filling/heating active
	Flashing green: filling/heating active / memory start
	Illuminated blue: machine is ready for operation
	Illuminated green: washing active
	Service access key/wake-up key
	i-menu
	Action menu
	Self-cleaning/drainage menu
	Open/close hood

Key/symbol	Meaning
	Programme: cutlery
	Programme: cups
	Programme: crockery
	Programme: pans
	Programme: glassware - gentle
	Programme: glassware - normal
	Programme: glassware - intensive
	Programme: glassware - gentle + cold water rinse
	Programme: glassware - normal + cold water rinse

8.2 Prepare dishwasher



Warning

Risk of injury from contact with chemicals

- Observe the safety data sheets and dosing recommendations of the chemical manufacturers.
- Use eye protection.
- Wear protective gloves.
- Do not mix different chemical products.

Beware

Danger of crushing

Body parts could be crushed when closing hood.

- When the hood starts to move downwards (manually or automatically operated hood), ensure that no body parts are between the hood and objects located underneath.
- Close manually operated hoods using the blue handle.

Beware

Danger of injury or material damage due to storing items on the hood

Items may fall down when hood moves.

- Ensure that no items are to be found on top of the hood.

System operators must be very familiar with the Operating Instructions of the dishwashing machine. Incorrect operation may result in personal injury or material damage.



1. Ensure the water supply is available.

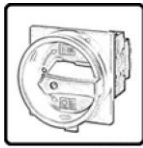

2. Switch on the local mains switch.

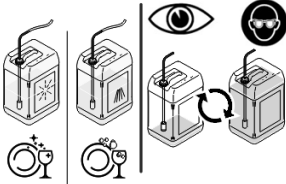

3. Check detergent and rinse aid and top up, if required, see chapter "Replace canister" on page 53.

4. Ensure that the hoses are fed down to the base of the container.



Note

If there is air in the hoses, the automatic dosing will not function correctly. The relevant pipe must be ventilated, see page 52.



5. If the display is dark, press the Wake-up key to activate the display.



6. a) Open hood with the relevant operation key **arrow upwards**.

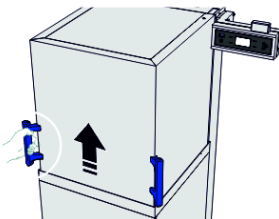

b) Open hood by tapping it.

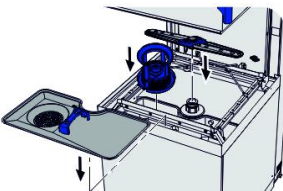

7. Insert filter, sieve and wash systems.



8. a) Close hood with the relevant operation key **arrow downwards**.

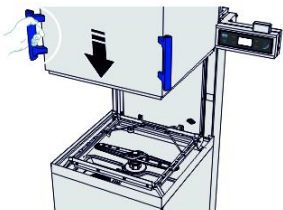

b) Close hood by tapping it.

8.2.1 Putting the machine into operation



If the display is dark, press the Wake-up key or move the door / hood.



1. Turn on the machine by pressing and holding the on/off key (for one second).

The machine is filling and heating up. The display changes depending on the process stage. The wash key is flashing.

- The display indicates **FILLING**.
- The display indicates **FILLING / HEATING**.
- When ready to operate, the display indicates **READY FOR OPERATION** and the wash key lights up permanently blue.



Note

The time required for the machine to be ready to operate depends on the temperature of the water supply and the installed boiler or tank heating capacity.

8.3 Washing

8.3.1 Putting away washware



- All hollow containers must always be loaded upside down. Otherwise the water will not be drained from the wash ware and brilliant drying will not be possible.

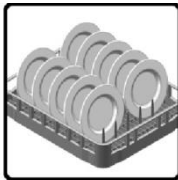

- Place plates, trays and dishes into the baskets at an angle. The inner surfaces face upwards.



- If cutlery holders are used, always insert the cutlery pieces with the handles down.
- Mix up the spoons, knives and forks as much as possible in each cutlery basket, since similar cutlery pieces may nest together.
- Do not put too many cutlery pieces into the individual cutlery baskets.



- Do not stack crockery items on top of each other in the basket. Direct access to the wash water would be more difficult and the washing times would have to be unnecessarily long. Shorter washing with baskets which are not overfilled is more economical.

8.3.2 Select wash programme

➡ The dishwashing machine is in **READY FOR OPERATION** mode **ECO MODE I-III**.



1. Select the desired wash programme using the confirmation key.



The symbol for the selected wash programme is displayed reversed against the background.

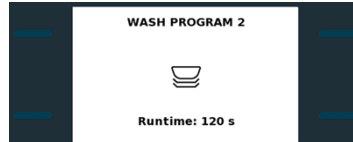

If the wash programme is changed, after approx. 3 seconds the runtime will be briefly displayed. This makes it possible to check that the correct wash programme has been selected.

























Programme configuration

Depending on the machine type, the electrical connection and water supply, the programme configuration can vary. The programme configuration is shown in the following tables.

Voltage		Version	M-iClean HM			M-iClean HL			M-iClean HXL		
Programmed channel			1	2	3	1	2	3	1	2	3
3NPE 400V	Glassware		3	6	11	3	6	11	3	6	11
	Crockery		7	9	12	7	9	12	7	9	12
	Thermolabel*		17	18	20	17	18	20	17	18	20
	A₀ 30*		19	22	24	19	22	24	19	22	24
Cold or hot water connection	Cold water final rinse*		15	16	2	15	16	2	15	16	2

*A reinforced tank heater may be required for these wash programmes.

M-iClean HM/HXL

Programme number	Programme cycle time	Boiler temperature	Tank temperature	Rinse water volume	Programme symbol
	[s]	[°C]	[°C]	[l]	
1	60	65	60	2,4/4,8	
2	60	65	60	2,6/5,2	
3	90	65	60	2,4/4,8	
4	90	65	60	2,6/5,2	
5	60	65	60	2,4/4,8	
6	120	65	60	2,6/5,2	
7	60	81	60	2,4/4,8	
8	90	81	60	2,4/4,8	
9	90	81	60	2,6/5,2	
10	120	81	60	2,6/5,2	
11	120	81	60	2,6/5,2	
12	210	81	60	2,6/5,2	
13	210	81	60	2,6/5,2	
14	240	81	60	2,6/5,2	
15	90	2	55	3,5/7,0	
16	120	2	55	3,5/7,0	
17	180	81	74	2,4/4,8	
18	240	81	74	2,6/5,2	
19	240	81	74	2,4/4,8	
20	300	81	74	2,6/5,2	
21	240	81	74	2,6/5,2	
22	300	81	74	2,6/5,2	
23	360	81	74	2,6/5,2	
24	360	81	74	2,6/5,2	
25	60	65	60	2,4/4,8	

























Programme assignment, see page 34.



Note

























If necessary, the washing pressure can be reduced by the MEIKO service (e.g. if the washware falls over).

M-iClean HM-PW/HXL-PW

Programme number	Programme cycle time	Boiler temperature	Tank temperature	Pressure level	Rinse water volume	Programme symbol
	[s]	[°C]	[°C]	[1-3]	[l]	
1	60	65	60	1	2.4/4.8	
2	60	65	60	2	2.6/5.2	
3	90	65	60	1	2.4/4.8	
4	90	65	60	2	2.6/5.2	
5	60	65	60	3	2.4/4.8	
6	120	65	60	2	2.6/5.2	
7	60	81	60	1	2.4/4.8	
8	90	81	60	2	2.4/4.8	
9	90	81	60	2	2.6/5.2	
10	120	81	60	1	2.6/5.2	
11	120	81	60	2	2.6/5.2	
12	210	81	60	3	2.6/5.2	
13	210	81	60	3	2.6/5.2	
14	240	81	60	3	2.6/5.2	
15	90	2	55	1	3.5/7.0	
16	120	2	55	2	3.5/7.0	
17	180	81	74	1	2.4/4.8	
18	240	81	74	2	2.6/5.2	
19	240	81	74	1	2.4/4.8	
20	300	81	74	3	2.6/5.2	
21	240	81	74	3	2.6/5.2	
22	300	81	74	2	2.6/5.2	
23	360	81	74	3	2.6/5.2	
24	360	81	74	3	2,6/5,2	
25	60	65	60	1	2.4/4.8	

Programme assignment, see page 34.

M-iClean HL

Programme number	Programme cycle time	Boiler temperature	Tank temperature	Pressure level	Rinse water volume	Programme symbol
	[s]	[°C]	[°C]	[1-3]	[l]	
1	60	65	60	1	3,0	
2	60	65	60	2	3,5	
3	90	65	60	1	3,0	
4	90	65	60	2	3,5	
5	60	65	60	3	3,0	
6	120	65	60	2	3,5	
7	60	81	60	1	3,0	
8	90	81	60	2	3,0	
9	90	81	60	2	3,5	
10	120	81	60	1	3,5	
11	120	81	60	2	3,5	
12	210	81	60	3	3,5	
13	210	81	60	3	3,5	
14	240	81	60	3	3,5	
15	90	2	55	1	4,0	
16	120	2	55	2	4,0	
17	180	81	74	1	3,0	
18	240	81	74	2	3,5	
19	240	81	74	1	3,0	
20	300	81	74	3	3,5	
21	240	81	74	3	3,5	
22	300	81	74	2	3,5	
23	360	81	74	3	3,5	
24	360	81	74	3	3,5	
25	60	65	60	1	3,0	

Programme assignment, see page 34.

8.3.3 Start wash cycle

Beware

Danger of crushing

Body parts could be crushed when closing hood.

- When the hood starts to move downwards (manually or automatically operated hood), ensure that no body parts are between the hood and objects located underneath.
- Close manually operated hoods using the blue handle.



The M-iClean H features 3 different options for starting a wash cycle (initiation functions):

- Wash key
- Touch operation
- **Intellistart** basket detection

The following 3 action steps are to be carried out before using any of the 3 options.

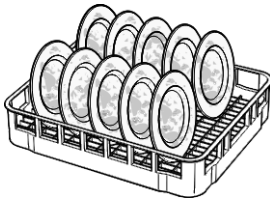

1. Clear the washware (removing any large food residues, napkins, tooth picks, lemon peel etc.).
2. Put the washware into the basket.

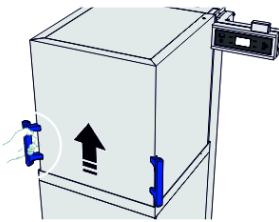

3. Open hood.

8.3.4 Operation using wash key

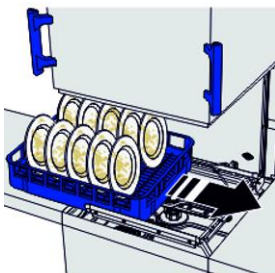

4. Insert the basket into the dishwashing machine.
5. Centre the basket correctly in the basket holder.



6. Ensure that the correct programme has been selected, see page 34.



7. Press the wash key.

The machine's hood will close. The wash cycle will start automatically.



The machine washes automatically and switches the programme off after completion. The display indicates the programme's progress.

The cycle time may differ from the set programme running time if the programme running time is not sufficient to heat up the fresh water to the pre-set temperature. In this case, the cycle runtime is automatically extended.

8.3.5 Touch operation

⚠ Beware

Special initiation function

Danger of injury to children; people with physical, sensory or mental impairments; people lacking in knowledge or experience

- Ensure that no persons from the above groups are to be found in the area surrounding the machine.
- Only qualified persons should perform work at and with the machine.
- If in doubt, deactivate special initiation functions which do not require conscious, intentional action (i.e. operation from the display).

Note

If chosen, the machine can be set so that the wash cycle starts as soon as the hood is closed. Otherwise, the wash key must be pressed.

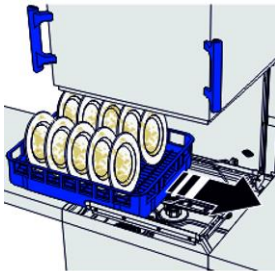

1. Insert the basket into the dishwashing machine.
2. Centre the basket correctly in the basket holder.



3. Ensure that the correct programme has been selected, see page 34.

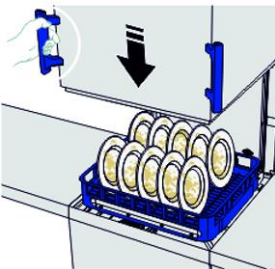

4. Tap the machine hood.



The machine's hood will close. The wash cycle will start automatically or on pressing the wash key.



The machine washes automatically and switches the programme off after completion. The display indicates the programme's progress.

The cycle time may differ from the set programme running time if the programme running time is not sufficient to heat up the fresh water to the pre-set temperature. In this case, the cycle runtime is automatically extended.

8.3.6 Rack detection (Intelli-Start) (option)

⚠ Beware

Special initiation function

Danger of injury to children; people with physical, sensory or mental impairments; people lacking in knowledge or experience

- Ensure that no persons from the above groups are to be found in the area surrounding the machine.
- Only qualified persons should perform work at and with the machine.
- If in doubt, deactivate special initiation functions which do not require conscious, intentional action (i.e. operation from the display).

Note

If chosen, the machine can be set so that the wash cycle starts 3 sec after inserting the basket. Otherwise, the hood must be tapped or the wash key pressed.

A wash cycle may be started by pressing the wash key when there is no basket in the machine (e.g. for cleaning).



1. Ensure that the correct programme has been selected, see page 34.

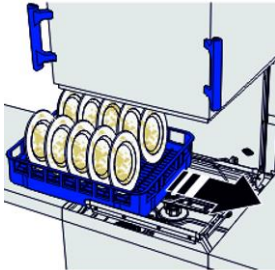

2. Insert the basket into the dishwashing machine.

3. Centre the basket correctly in the basket holder.

The machine detects the basket automatically.

- Either: the hood will close after 3 sec.
- Or: tap the hood (configuration setting).
- Or: press the wash key (configuration setting).

The wash cycle will start automatically.



The machine washes automatically and switches the programme off after completion. The display indicates the programme's progress.

The cycle time may differ from the set programme running time if the programme running time is not sufficient to heat up the fresh water to the pre-set temperature. In this case, the cycle runtime is automatically extended.

8.3.7 Emptying the washware

⚠ Beware

Danger of burns and scalding due to hot rinse water, washware and machine parts

Contact with hot rinse water, washware and machine parts can result in burns/scalding of the skin.

- Wear protective gloves if necessary.
- Let the washware cool down before emptying, if necessary.
- Let the machine cool down before touching machine parts, if necessary.
- Never open the machine door or hood during a wash cycle.
- Only open and close the hood/door using the designated handle(s).



At the end of the programme, the wash key changes colour from green to blue.

The hood opens immediately (depending on parameter settings) and the display shows as ready for operation.

With closed hood:



1. a) Open hood with the relevant operation key **arrow upwards**.

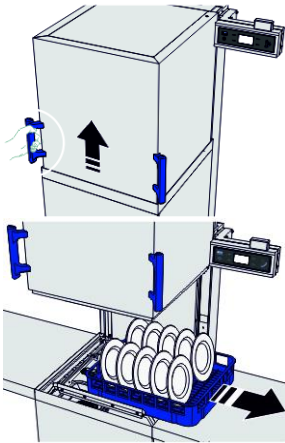

- b) Open hood by tapping it.

2. Carefully remove the basket.



- a) New wash cycle: insert fresh basket and start wash cycle.
 - b) Close hood with no wash cycle: close with the relevant operation key arrow downwards.

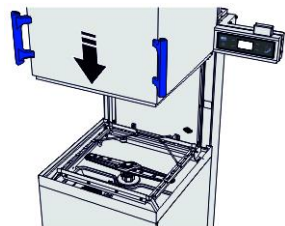

The hood closes, saving energy, or a further wash cycle runs.

8.3.8 Closing the hood without triggering automatic wash start

Option 1: automatic wash start has not been activated, see chapter “**Action menu**” on page 48.

➡ The wash cycle does not start after pressing the **Close hood** button, touching the hood or manually closing it.

➡ Additionally: wash start will not work on dishwashing machines with rack detection depending on the configuration ordered and the rack inserted.

Option 2: automatic wash start has been activated, see chapter “**Action menu**” on page 48.

➡ The wash cycle does not start when the **Close hood** button is pressed. When manually operating the hood, it must be closed within 10 s of pressing **Close hood**.

➡ Additionally: wash start will not work on dishwashing machines with rack detection depending on the configuration ordered and the rack inserted.

8.3.9 Prevent rinsing start on machines without automatic hood system



The hood should be closed without starting a programme. After the last wash cycle has been carried out, the **Stop wash start** icon is displayed.

When the corresponding confirmation button is pressed in the upper right corner, the **Close hood** symbol is shown in the display. The operator can now close the hood within 10 seconds without starting the programme. The key must then be pressed again. If necessary, running i-menu sessions must be terminated beforehand with the service access key, see chapter “Change authorisation level” on page 46!

8.4 Malfunctions

If the described operational problems occur repeatedly, the cause must be identified.

Occasional malfunctions

Malfunction	Possible cause	Remedy
Dishwashing machine doesn't fill up	No water present	Open the shut-off valve
	Dirt trap clogged	Clean the dirt trap
	Open hood	Close hood
Final rinse does not spray	No water present	Open the shut-off valve
	Dirt trap clogged	Clean the dirt trap
Streaks / smears on the washware	Unsuitable rinse aid	Change product
	Incorrect dosing quantity	Adjust dosing quantity
	Water pre-treatment defective	Check water pre-treatment
Strong formation of foam in the wash tank	Dirt level too high	Prepare the washware more thoroughly/change tank water more frequently
	Manual dishwashing detergent used	Do not use a foaming manual dishwashing detergent for precleaning or for cleaning the machine. Foam can cause malfunctions in the dishwashing machine and a poor washing result.
	Unsuitable detergent	Change product
	Unsuitable rinse aid	Change product

Hood no longer opens/closes automatically	see chapter "Restricted operation" on page 45
---	---

Rare malfunctions

Malfunction	Possible cause	Remedy
Hood remains in an open position and can no longer be easily moved by hand	Fault with hood spring	Not possible to continue working. Call a service technician!

As a rule, faults that are not described here require assistance from an authorised service technician. Please contact your subsidiary or authorised dealer.

8.4.1 Messages



When a malfunction occurs, a grey or red message is shown on the display depending on the nature of the malfunction.

- Grey messages can be acknowledged using the relevant confirmation key.
 - Red messages usually require the deployment of an authorised service technician.
- When these messages occur:

1, 100, 102, 104, 107, 108, 109, 110, 150, 201, 203, 204, 206, 207, 208, 209, 330, 420, 425, 427, 880, 901/902, 931-945, 960.

- Not possible to continue working
- Switch off on-site power supply
- Close on-site water supply
- Call a service technician!

No.	Display text	Measures/remedial action
6	Programme interrupted prematurely	<ul style="list-style-type: none"> • Start wash cycle again
11	Carry out maintenance	<ul style="list-style-type: none"> • Possible to continue working • Call a service technician!
12	Code entry wrong!	<ul style="list-style-type: none"> • Enter correct entry code
15	Heat recovery cancellation	<ul style="list-style-type: none"> • Allow the heat recovery process to run to completion.
16	Hood not closed	<ul style="list-style-type: none"> • Close hood.
17	Emptying / Closing the hood	
18	Water change / Close hood	
19	"Lower" hood switch indicators do not match up: S7: "1"; S8: "0"	<ul style="list-style-type: none"> • Open/close hood • Able to continue working at limited capacity • Call a service technician!
20	"Lower" hood switch indicators do not match up: S7: "0"; S8: "1"	
101	Drainage level not reached	<ul style="list-style-type: none"> • Check the drainage sieve, clean if necessary • Call a service technician if needed
103	Tank temperature not reached	<ul style="list-style-type: none"> • Possible to continue working • Call a service technician
106	Wash time increase insufficient	<ul style="list-style-type: none"> • If this message reoccurs, call a service technician
111	Water loss in wash tank	<ul style="list-style-type: none"> • If this message reoccurs, call a service technician

No.	Display text	Measures/remedial action
112	Forced drainage due to permanently filled wash tank	<ul style="list-style-type: none"> • Change the water or drain the machine at least once a day
113	Left fine/coarse filter missing	<ul style="list-style-type: none"> • Correctly insert fine/coarse sieve • If this message reoccurs, call a service technician
114	Fine/coarse sieve missing	
115	Drain pump active after triggering of the safety level	<ul style="list-style-type: none"> • Possible to continue working
116	Refill error in wash tank	<ul style="list-style-type: none"> • If this message reoccurs, call a service technician
117	Top wash system blocked/missing	<ul style="list-style-type: none"> • Ensure wash arm system can move freely • If applicable, insert wash arm system • Where appropriate, remove dirt particles and ferrous metal particles from the magnet
118	Bottom wash arm system blocked/missing	
120	Top-left wash system blocked/missing	
121	Bottom-left wash arm system blocked/missing	
127	Temperature increase not reached	<ul style="list-style-type: none"> • If this message reoccurs, call a service technician
151	Hood hit an obstacle	<ul style="list-style-type: none"> • Remove obstacle
153	Hood hit an obstacle while opening	
154	Error moving away from lower hood limit switch	<ul style="list-style-type: none"> • Call a service technician • Possible to continue work at limited capacity
155	Error approaching lower hood limit switch	
156	Hood motor not working	<ul style="list-style-type: none"> • Remove obstacle • Where appropriate, call a service technician
157	Error moving away from upper hood limit switch	<ul style="list-style-type: none"> • Call a service technician • Possible to continue work at limited capacity
158	Error approaching upper hood limit switch / Hood drive pulse generator error	
159	Open hood	<ul style="list-style-type: none"> • Open and close hood
160	Upper/lower hood limit switches activated simultaneously	<ul style="list-style-type: none"> • Open and close hood • Possible to continue working • Call a service technician!
161	Automatic operation deactivated Manual operation active	<ul style="list-style-type: none"> • Possible to continue work at limited capacity • see chapter "Restricted operation" on page 45
162	Automatic operation is possible again Activate?	<ul style="list-style-type: none"> • Confirm message
163	Activation of automatic hood operation performed. Restricted operation ended when hood is operated manually.	<ul style="list-style-type: none"> • No action required • Possible to continue working
200	Boiler level not reached on time during filling	<ul style="list-style-type: none"> • Open the local water supply • Check pre-filter/sieve and clean, if necessary
205	Maximum final rinse cycles insufficient	<ul style="list-style-type: none"> • Sort washware correctly • Possible to continue working
212	Forced drainage due to permanently filled boiler	<ul style="list-style-type: none"> • Change the water or drain the machine at least once a day
213	Pressure booster pump or air catch defective	<ul style="list-style-type: none"> • Check the rinse system and clean, if required • If this message reoccurs, call a service technician
301	Lack of rinse aid	<ul style="list-style-type: none"> • Replace canister • If necessary, check and clean the position of the suction lances
311	Lack of detergent	

No.	Display text	Measures/remedial action
406	Advance report: cartridge nearing end of life	<ul style="list-style-type: none"> • Have a replacement cartridge ready • Replace when notification 407 appears
407	Change demineralisation cartridge	<ul style="list-style-type: none"> • Change demineralisation cartridge
408	Change osmosis system pre-filter	<ul style="list-style-type: none"> • Replace pre-filter
410	Water supply reverse osmosis module disturbed	<ul style="list-style-type: none"> • Open water inlet valve • Check pre-filter/sieve and clean or replace, if applicable
421	Insufficient water in holding tank	<ul style="list-style-type: none"> • Open water inlet valve • Where appropriate, call a service technician
422	Max. level not reached in holding tank	
423	Water feed into holding tank insufficient	
426	Osmosis membrane blocked/dirty	<ul style="list-style-type: none"> • Possible to continue work at limited capacity • Check pre-filter and replace if necessary • Call a service technician!
500	Energy optimisation active	<ul style="list-style-type: none"> • No action required
501	Energy optimisation active Tank temperature not reached	<ul style="list-style-type: none"> • Possible to continue working • Call a service technician!
502	Energy optimisation active Wash time increase in tank insufficient	<ul style="list-style-type: none"> • Possible to continue working • If this message reoccurs, call a service technician
503	Energy optimisation active Temperature increase not reached	<ul style="list-style-type: none"> • If this message reoccurs, call a service technician
504	Energy optimisation active Final rinse temperature not reached	<ul style="list-style-type: none"> • Call a service technician!
505	Energy optimisation active Wash time increase on final rinse insuff.	<ul style="list-style-type: none"> • If this message reoccurs, call a service technician
892	Communication with SMART WIRE node addr. 13	<ul style="list-style-type: none"> • Possible to continue working • Call a service technician!
963	Bluetooth access error	<ul style="list-style-type: none"> • Confirm message • Possible to continue working • Call a service technician!
969	Low battery	<ul style="list-style-type: none"> • Confirm message • Able to continue working at limited capacity • Call a service technician!
971	Operating panel re-initialising	<ul style="list-style-type: none"> • If this message reoccurs, call a service technician

If an error message is displayed that is not in this list, please contact the authorised service technician.

8.4.2 Restricted operation

In case of a malfunction of the automatic hood system, the machine switches to restricted operation. The dishwashing machine can still be used for rinsing, but the hood must be opened and closed manually as far as it will go. The programme can only be started via the wash key.

During restricted operation, message 161 is permanently displayed. The cause of the fault (messages 19, 20, 157, 158 and 160) lies in contradictory or non-existent signals concerning the upper and lower hood position.

Troubleshooting

Normally, it is sufficient to perform a complete hood drive (open/closed/open) at moderate speed for calibration. If successful, a message 162 to be acknowledged may appear, and if the software is newer, a message 163 not to be acknowledged. The machine then resumes normal operation.

It is also possible to disconnect the machine completely from the power supply (no emptying is necessary). After initialisation, all functions are available again.

8.5 Shutting down the dishwasher



1. Press on/off key.

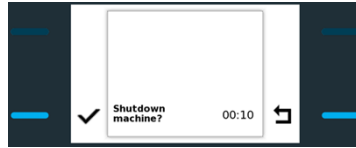

✓ 2. Confirm request with the relevant confirmation key.

➔ The dishwashing machine will self clean.

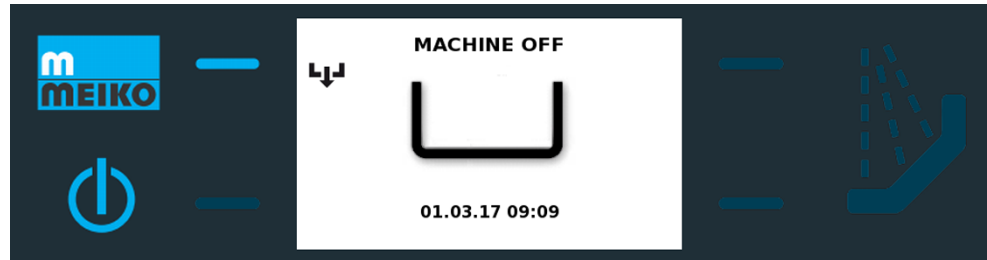

➔ Once the self-cleaning process is complete, the dishwashing machine will switch to **MACHINE OFF** mode.

8.6 Change authorisation level



Note

The dishwashing machine must be in **MACHINE OFF** mode.

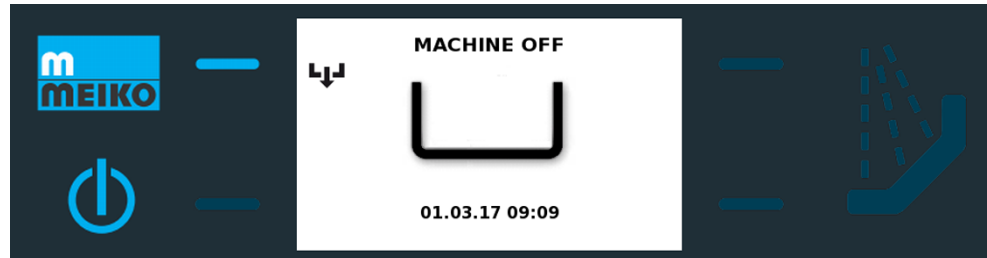

1. Press and hold the Service access key for approximately three seconds.

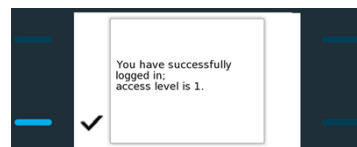

2. Enter the service code for the required authorisation level.

✓ 3. Confirm the message.

Authorisation level 1 – user configuration level

Read settings (**service code: 10000**)

The user can view the user settings.

Read/modify settings (**service code 10001**)

The user can carry out all functions required for normal operation and configure the settings.

Authorisation level 4 – extended configuration level

Read settings (**service code: 40000**)

The user can view the extended settings.

Read/modify settings (**service code 40044**)

















In addition to the functions and settings for authorisation level 1, the operator can view/edit all the relevant parameters for the dosing equipment. The i-menu shows all variable parameters in the corresponding tabs (dosing system, wash programs).









Note

Certain menu functions in i-menu and the action menu have to be enabled by an authorised service technician before the operator can use them (reset counter, etc.).

i-menu

	Symbol	Level	Description
Languages		1, 4	Set display language
Hood movement		1, 4	Lift/lower hood and view status
Wash tank		1, 4	Set automatic hood opening and descaling parameters View status
Final rinse		1, 4	View status
Chemicals		1	Set dosage quantity for detergent and rinse aid
Water treatment		1	Set degree of hardness and treatment parameters
Heat recovery		1	No user settings
Energy optimisation		1, 4	No user settings
Global		1	Set wash programme channels and Bluetooth communication
Operational times		1,4	View batches, operational times, etc.
Daily protocol		1,4	View archived operational times, events, etc.
Wash programmes		4	Set quantity of rinse aid and fine tune dosing
Settings		1,4	Set date/time, reset counter, notification settings
General		1,4	View software version, machine serial number, machine type
Dosing system		4	Dosing parameters for the dosing technician

Action menu

	Symbol	Level	Description
Ventilate detergent pipe		1, 4	Starts detergent or rinse aid dosing pump to ventilate the transport pipes when required, e.g., when the canisters are empty during operation.
Ventilate rinse pipe		1, 4	
Automatic wash start		1, 4	Active: hood closes on touch, then wash starts Inactive: hood closes on touch, but wash does not start
Manually start water change		1, 4	If automatic wash tank water regeneration with fresh water is insufficient, an additional water change may be necessary.
Descaling		1, 4	Starts descaling programme.
Reset counter		1, 4	Reset the interval for the pre-filter change of the reverse osmosis module.

8.7 Reset the counter



Note

In order to be able to reset counters in security access level 1, this function must be separately enabled by an authorised MEIKO service technician. Resettable counters:

- Maintenance counter
- Reverse osmosis (UO) filter insert

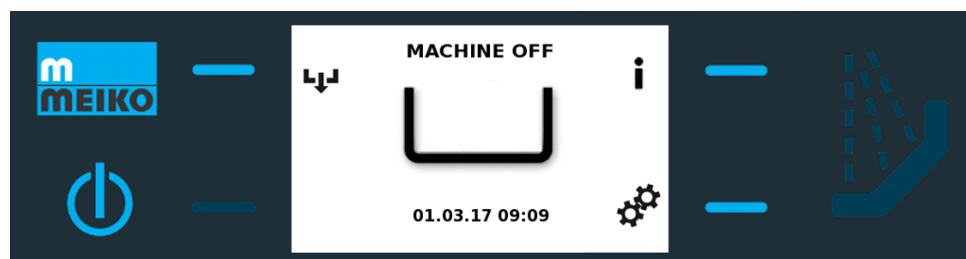

1. Switch to security authorisation level 1 **user configuration level**, see page 46.



2. Call up the i-menu using the relevant confirmation key.



3. Switch to the **Settings** tab page.



4. Select the item **reset counter**.



5. Confirm the selection.

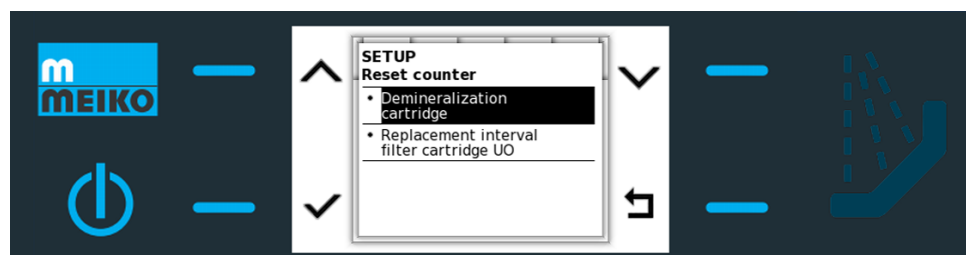

- ✓ 6. Select the counter to be reset.
- ✓ 7. Confirm the selection to reset the values.



Note

The counters for the water treatment options can also be reset via security authorisation level 4 **Extended configuration level**, see page 46.

8.8 Adjust dosing quantity

1. Switch to security authorisation level 1 user configuration level, see page 46.
- i 2. Call up **i-menu** using the relevant confirmation key.
3. Select the **CHEMICAL PRODUCT** tab
4. Select and confirm the **Parameter** item.
5. Select and confirm the **Rinse aid dosing quantity** or **Detergent dosing quantity** item.
6. Change the value with **+/-** and confirm.

8.9 Activate/deactivate Bluetooth interface



Note

The Bluetooth interface allows the service technician to read the machine's data and is used for software updates. It is switched on as standard. If necessary, the interface can be deactivated by the user.

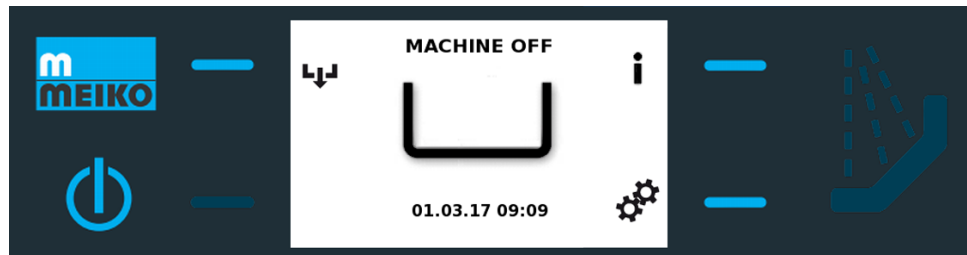

1. Switch to security authorisation level 1 **user configuration level**, see page 46.
- i 2. Call up i-menu using the relevant confirmation key.
- ⚙ 3. Switch to the **global** tab.
- ✓ 4. Select the item **parameters**.
- ✓ 5. Confirm the selection.
- ✓ 6. Select the item **release Bluetooth communication**.
- ✓ 7. Confirm the selection.
- ✓ 8. Select the item **no**.
- ✓ 9. Confirm the selection.

8.10 Private Label 2.0

If desired, one or more individual motifs can be shown on the dishwashing machine operating panel. The user can choose between a screen saver during operation (slide show) and/or a welcome screen when the supply voltage is switched on.

The option can be selected directly when ordering the machine, or can be ordered later from the dealer/service partner.

The welcome screen is just displayed for a few seconds after switching on the power supply.

The screen saver will be displayed after 6 minutes of no user action if the machine is in the READY FOR OPERATION/ ECO MODE status. The uploaded images are displayed in a slide show (interval of 5 seconds). The interval can be changed via Settings - Display - Single image display duration. The screen saver can be left by means of any user action.

1. Have the machine's serial number ready. It can be found on the rating plate or can be read off the operating panel by pressing (3 s) the service access key.

2. Send the serial number in the e-mail subject to privatelabel@meiko-global.com and receive a voucher code in response. This only works if you order the option in advance!

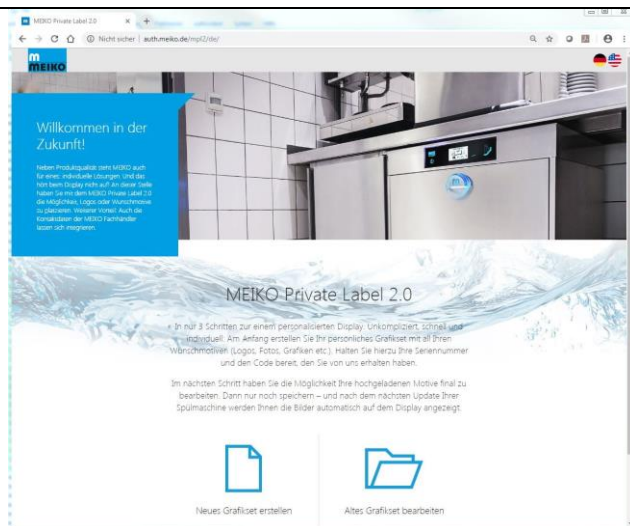

Im nächsten Schritt haben Sie die Möglichkeit Ihre hochgeladenen Motive final zu bearbeiten. Dann nur noch speichern – und nach dem nächsten Update Ihrer Spülmaschine werden Ihnen die Bilder automatisch auf dem Display angezeigt.



3. Go to the <https://privatelabel.meiko-global.com> website.

4. Click on the "Create new graphics set" button.

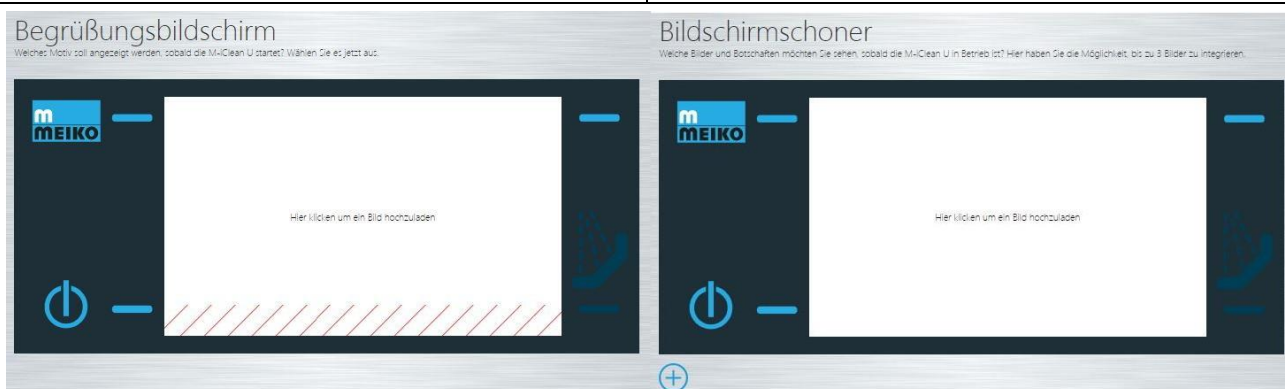

The selection menu for uploading the welcome screen and screen saver appears.

+ can be used to upload two additional screen saver motives, if required.

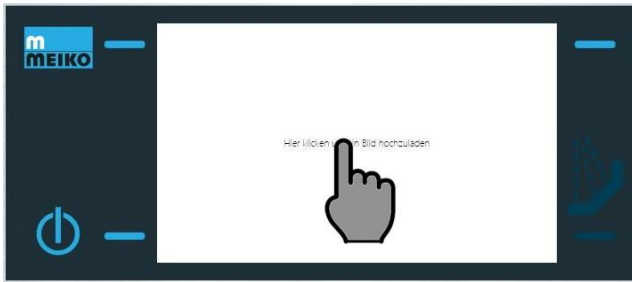

5. Click in the display to upload.

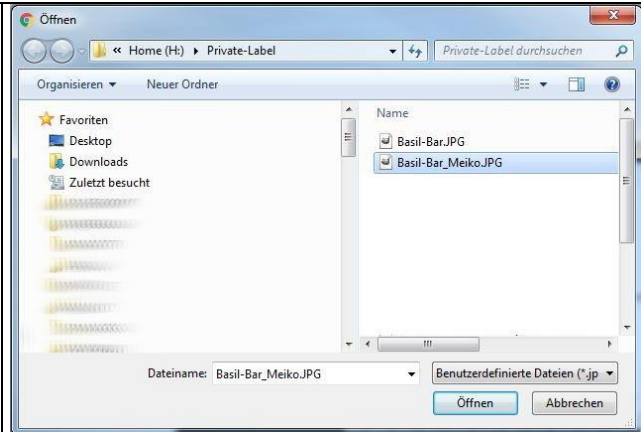

6. Select file.



7. Adjust the size and position, rotate if necessary. Confirm by ticking the checkbox.



8. Assess the result, edit or discard if necessary. Repeat steps 5-7 for more motives.

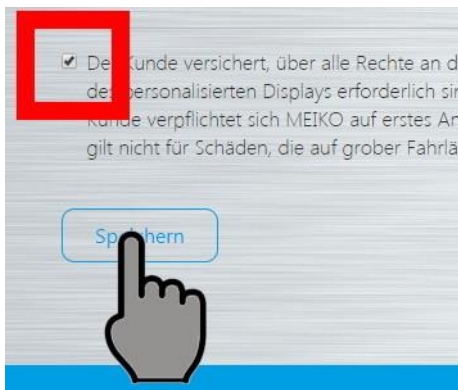

9. Tick the checkbox before saving.



10. Enter the serial number and voucher code.



That's all! Your Private Label will be transferred to the machine during the service technician's next visit.

8.10.1 Setting waiting time for Private Label

1. Switch to authorisation level 1, see page 46.
2. The waiting time can be changed in the i menu under **Settings- Display- 2nd waiting time until Start Private Label (0 means: always ON= no screen protector or 2nd waiting time deactivated).**
3. Press the MEIKO key for 3 seconds and confirm the request to log off from the current session.

8.11 Setting the waiting time for dimming the display brightness

1. Switch to authorisation level 1, see page 46.
2. The waiting time until dimming can be changed in the i-menu under **Settings-Display- Waiting time until TFT 50% reduced (0 means: always ON= no dimming)**.
3. Press the MEIKO key for 3 seconds and confirm the request to log off from the current session.

8.12 Ventilating the pipes

The detergent or rinse aid pipes must be ventilated, if air is sucked in from the dosing equipment. This occurs if a storage container is completely emptied during operation, or if one of the suction lances is not positioned right down to the base of the container.

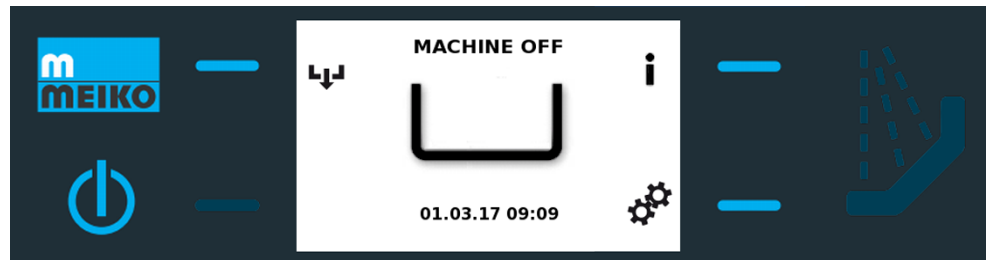

1. Switch to authorisation level 1 **User configuration level**, see page 46.



2. Call up the action menu using the relevant confirmation key.

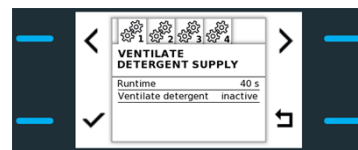
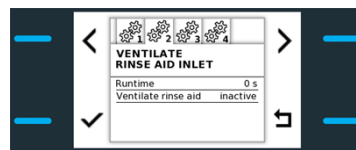

3. Select the required submenu.



4. Start the ventilating procedure by using the relevant confirmation key.

8.13 Perform a manual water change

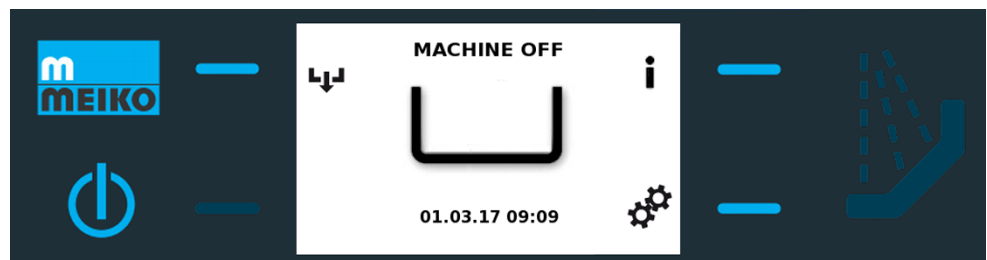

1. Switch to authorisation level 1 **User configuration level**, see page 46.



2. Call up the action menu using the relevant confirmation key.

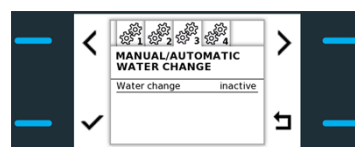

3. Select the required submenu.



4. Start the water change by using the relevant confirmation key.

8.14 Replace canister



⚠ Warning

Risk of injury from contact with chemicals

- Observe the safety data sheets and dosing recommendations of the chemical manufacturers.
- Use eye protection.
- Wear protective gloves.
- Do not mix different chemical products.

Note

The canisters for detergent and rinse aid are located in close proximity to the dish-washing machine.

Note

When using a suction lance which detects whether a canister is empty, a shortage of detergent or rinse aid will be indicated on the display.



A canister is empty.

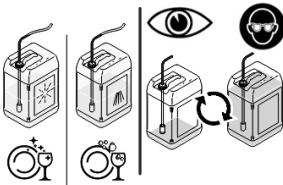

1. Remove the suction lance from the empty canister and insert it into a full canister.

2. If necessary, ventilate the pipelines, see page 52.

9 Maintenance and cleaning



⚠ Warning

Danger to life from electric shock

Contact with live electrical parts can lead to serious injury or death.

- Work at or repairs to the electrical system must be conducted by a qualified electrician who complies with the electrotechnical rules.
- Disconnect the machine from the power supply before working on the electrical system. To do this, turn the local mains switch to **OFF** and ensure that it can't be switched back on again.



⚠ Warning

Danger to life from electric shock if cover panels are open

If the machine is operated without cover panels, electrified parts are freely accessible. Contact with these parts can lead to serious injury or death.

- Disconnect the machine from the power supply before opening the cover panels. To do this, turn the local mains switch to **OFF** and ensure that it cannot be switched back on again.
- Attach all cover panels before placing the machine back in operation.



⚠ Warning

Danger of injury from entering a danger zone

Unauthorised persons might be in or enter the danger zone during transport, assembly, commissioning, maintenance and repair work. This can lead to injuries.

- Only permit qualified persons to perform work at the machine.
- Remove unauthorised persons from the danger zone.
- Cordon off danger zone and signpost it for third parties.

- Never remove or disable safety devices on the machine.
- Always wear cut-resistant protective gloves when removing housing parts and when working inside the machine!

Beware

Danger of burns and scalding due to hot rinse water, washware and machine parts

Contact with hot rinse water, washware and machine parts can result in burns/scalding of the skin.

- Wear protective gloves if necessary.
- Let the washware cool down before emptying, if necessary.
- Let the machine cool down before touching machine parts, if necessary.
- Never open the machine door or hood during a wash cycle.
- Only open and close the hood/door using the designated handle(s).

Beware

Danger of crushing

Body parts could be crushed when closing hood.

- When the hood starts to move downwards (manually or automatically operated hood), ensure that no body parts are between the hood and objects located underneath.
- Close manually operated hoods using the blue handle.



Beware

Danger of injury or material damage due to storing items on the hood

Items may fall down when hood moves.

- Ensure that no items are to be found on top of the hood.

Caution

Environmental damage due to improper disposal of liquids

Environmentally hazardous liquids (e.g. grease and oils, hydraulic oils, coolants, cleaning agents containing solvents etc.) may be used during work on and with the machine. Improper disposal of these liquids can damage the environment.

- Always capture, store and transport liquids in suitable containers.
- Never mix liquids.
- Dispose of liquids properly in accordance with local requirements.



9.1 Maintenance



Note

Maintenance work must only be carried out by an authorised in-house technician or an authorised service technician.

Cleaning work and changing pre-filter in dishwashers with GiO Module must be carried out by trained operators.

The dishwasher has been designed to keep the need for cleaning, care and maintenance to a minimum.

However, for reliable, safe and long-term function of the machine, and in the interest of hygiene and cleanliness, correct care and maintenance are necessary.

We recommend concluding a maintenance contract with our subsidiary in order to ensure a long service life of the dishwasher.

A functional test on all safety systems of the machine is carried out during every regular maintenance.

- Comply with the maintenance intervals prescribed in these operating instructions.
- Please note the maintenance instructions for the individual components in these operating instructions.
- Carefully dispose of any cleaning products that could harm the environment.

9.2 Maintenance table

Maintenance work	U= M-iClean H=M-iClean	Checked	Cleaned	Replaced	Maintenance requirement
Visual inspection					
1. Error memory					
Check error memory for unusual events	U/H				annually
2. Pumps					
Check pumps for leaks and any visible damage	U/H				annually
Check pumps for pump rotor noise and function	U/H				annually
3. Wash tank, wash and rinse system					
Functional and visual tests of wash and rinse arms	U/H				annually
Replace sealing rings on wash arms	U/H				annually
Check air trap on tank and clean if necessary	U/H				annually
Check tank level control for leaks	U/H				annually
Check sieves and filters	U/H				annually
Check rack holder/guide for damage	U/H				annually
Check wash and rinse systems for leaks	U/H				annually
Check water level in tank	U/H				annually
Check door seal	U				annually
Check seal on coarse sieve/drain pump	U				annually
Check tank and boiler heating	U/H				annually
4. Casing					
Check casing, tank and covers for damage and correct operation	U/H				annually
Check door and door counter balance for correct operation	U				annually
5. Hood and hood counterbalance					
Check hood movement for running noise	H				annually
Remove bearing block <ul style="list-style-type: none"> • Check rollers in bearing block • Clean drain hole in hood 	H				annually
Visually check hood mounting	H				annually
Clean hood guide rails and back wall seal	H				annually
Check handles sit firmly and, if necessary, tighten screws	H				annually
Check life span of springs and chains <ul style="list-style-type: none"> • Replacement • HM/HL and EcoTemp ET 15.1/17.1: replace guide block for protective rod and mounting plate for springs • HXL: replace guide block, only replace mounting plate if necessary 	H				annually after 650,000 loads or 12 years
Clean running surfaces on square tubing	H				annually
6. Fresh water installation					
Check valves, clean dirt trap	U/H				annually
Check that the boiler level control/air trap are not leaking	U/H				annually
Check boiler, hoses, clamps and plastic parts do not leak	U/H				annually

Check boiler drainage system does not leak	U/H				annually				
7. Wastewater installation									
Replace flap on ventilation valve	U/H				annually				
Check operation of drain pump during drainage	U/H				annually				
Check pumps, hoses and wastewater heat exchangers (optional extra) are not leaking	U/H				annually				
8. Detergent dosing									
Replace peristaltic hose and seals on the nozzles	U/H				annually				
Check detergent dosing system is working and not leaking	U/H				annually				
9. Rinse aid dosing									
Replace peristaltic hose and seals on the nozzles	U/H				annually				
Check rinse aid dosing system is working and not leaking	U/H				annually				
10. Test run including functional test of whole machine									
Check filling and heating until it is ready for operation	U/H				annually				
Visual inspection of the entire machine for leaks	U/H				annually				
Check results of test wash and rinse	U/H				annually				
11. Options									
Integrated reverse osmosis system (if applicable)									
Visually check whole system for leaks	U/H				Annually				
Change pre-filter (standard membrane (<0.1 mg/l))	U/H				Every six months				
Change pre-filter (chlorine-resistant membrane (≥ 0.1 and ≤ 2.0 mg/l))	U/H				Every three months				
Check fine sieve insert and choke in concentrate pipeline	U/H				Annually				
Check correct function of concentrate drain and check for deposits	U/H				Annually				
Fill in separate log, "Certificate of Commissioning, GiO"	U/H				Annually				
Partial demineralisation (PD) / Full demineralisation (FD) (if available)									
Functional test	U/H				Annually				
Heat retention system (if applicable)									
Visually check lever arm	H				Annually				
Check sheeting for damage	H				Annually				
Functional test	H				Annually				
Exhaust air heat recovery (if applicable)									
Functional test of fan	U/H				Annually				
Functional test of solenoid valve	U/H				Annually				
Visual inspection and leak test	U/H				Annually				
Thermal disinfection (if available)									
Replace hood seal profile (HL)	H				Annually				
12. Water quality, temperature									
Drinking water	°C	°dH	°CH	µS/cm	U/H				annually
Water quality after water treatment (if applicable)		°C	°dH	µS/cm	U/H				annually
13. Electrical safety check (certificate is optional)									
Carry out the visual inspection	U/H								annually
Check the protective earth conductor	U/H								annually
Insulation resistance measurement	U/H								annually
Measure current on protective earth conductor	U/H								annually

9.3 Daily cleaning

Caution

Material damage due to water ingress

Electrical cables and electronic components can be damaged if they come into contact with water.



- The dishwashing machine, switch cabinets and other electrical components must **never** be sprayed with a hose or high pressure cleaner.
- Make sure that no water can enter the machine unintentionally.
- If installed at ground level, **never** flood the surrounding room.

When machine is drained, see page 46.



1. a) Open hood with the relevant operation key **arrow upwards**.

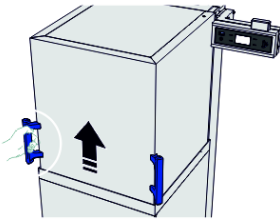

- b) Open hood by tapping it.

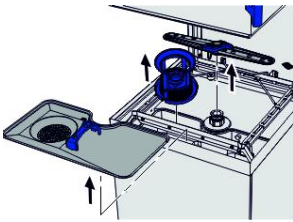

2. Remove sieve, filter and wash system.

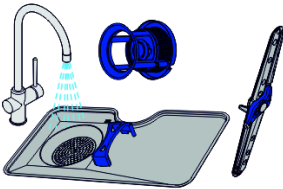

3. Remove all food residues sticking to the tank, the tank heater and the filters using a brush.
4. Remove the wash and rinse arm and rinse thoroughly under running water. When doing this, pay particular attention to the nozzles!
5. Clean filter under running water.

Do not use a foaming manual dishwashing detergent for pre-cleaning or for cleaning the machine. Foam causes malfunctions and results in poor wash results.

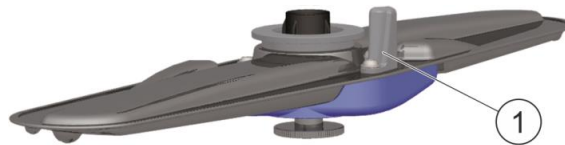

6. To ensure that the sensor detects the rotation of the washing arm, remove all dirt particles and ferrous particles sticking to the magnet (1).
7. Reinstall all parts.

9.4 Cleaning the stainless steel surfaces

Caution

Material damage due to incorrect cleaning

Cleaning of parts made of stainless steel with unsuitable cleaning agents, care products and cleaning utensils leads to damage, deposits or discolourations on the machine.

- Never use aggressive cleaning or scouring agents.
- Never use cleaning agents that contain hydrochloric acid or bleaches based on chlorine.
- Do not use cleaning utensils previously used to clean non-stainless steel.

Caution

Material damage due to aggressive cleaning products

The use of aggressive cleaning and care products near the machine can cause damage to the machine due to their fumes.

- Make sure that the cleaning and care products cannot have direct contact with the machine.
- Do not use aggressive cleaning agents (e.g. aggressive tile cleaner) to clean the surrounding area.
- Please observe the notes on the product packaging.
- In case of uncertainty, request information from the suppliers of these products.

We recommend that, when required, the stainless steel surfaces are cleaned exclusively using cleaning and care products that are suitable for stainless steel.

- Lightly soiled parts can be cleaned with a soft and possibly damp cloth or sponge. For moistening we recommend only using demineralised water.
- In order to prevent limescale, we recommend wiping the surfaces thoroughly dry after cleaning.

9.5 De-scaling



Warning

Danger of injury from contact with acids

Descaling agents can cause damage to health if they come into contact with skin or eyes or are swallowed.

- Use eye protection.
- Wear protective gloves.
- Contact a physician immediately if chemicals or water containing chemicals (rinse water) are swallowed.
- Please take note of the manufacturer's safety instructions.

Operating the machine using hard water can result in the build up of limescale deposits in the boiler and the tank interior. If this occurs, it is necessary to descale the tank interior, boiler housing, tank heating, boiler heating and the washing and rinse systems.

Using service code "40044" you can reach authorisation level 4 (see page 46). Here the "descale" function (for the wash tank) can be selected from the pull-down menu.



The descaling time and temperature can be adjusted in the i-Menu under the tab "Dosing technology".

- For descaling only use products suitable for industrial dishwashing machines.

9.6 Spare parts

Please provide the following information on any query and/or when ordering spare parts:

Type:
SN:

(This information can be found on the type plate, see page 16.)

10 Dismantling and disposal

In addition to valuable raw materials and recyclable materials, the packaging and the old device may also contain substances that are harmful to health and the environment and were required for the function and safety of the old device.

Please do not dispose of your old device in residual waste. Instead, contact your dealer or the collection points set up in your community for information regarding the disposal of your old device.

10.1 Disposal of packaging materials

All the packaging materials are recyclable. The following materials are used:

- Square timber frame
- Plastic sheeting (PE film)
- Cardboard packaging (for protecting edges)
- Packaging strap (steel strip)
- Packaging strap (plastic (PP))



Note

The square timber frame consists of untreated raw pine / spruce. In order to guard against pests, country-specific import regulations may also stipulate the use of treated wood.

10.2 Dismantling and disposal of the old device

Warning



Risk of injury from contact with chemicals

- Observe the safety data sheets and dosing recommendations of the chemical manufacturers.
- Use eye protection.
- Wear protective gloves.
- Do not mix different chemical products.

-
- Where appropriate, rinse machine components, containers, dosing units and hoses with fresh water to remove chemical residues. Wear suitable clothes (gloves, safety glasses) for this.



The device is marked with this symbol. Please observe the local regulations for proper disposal of your old device.

The components should be separated by material for recycling.

11 Abbreviations

Abbreviation	Meaning
GiO	GiO module, integrated reverse-osmosis system
pH	The pH value denotes the acidity of liquids
LpA	LpA denotes the emission sound pressure levels at the workplace
dB	Decibel, unit of sound pressure level.

12 Index

A	
A0 control.....	20
Abbreviations.....	60
Action menu.....	48
Adjust dosing quantity.....	49
AirConcept.....	21
Assembly.....	22
Authorisation level	
action menu.....	48
Advanced.....	47
i-menu.....	47
User.....	46
Automatic hood system.....	19
Automatic wash start.....	42, 48
B	
Blue operating concept.....	17
Bluetooth interface	
Deactivate.....	49
C	
Change authorisation level.....	42, 46
Change of products.....	18
Checking the condition at delivery.....	23
Cleaning	
sieve cover.....	16
suction strainer.....	16
wash arm.....	16
Cleaning the stainless steel surfaces.....	58
Commissioning.....	28
prerequisites.....	29
D	
Daily cleaning.....	57
Delivery contents.....	6
Descaling.....	48
De-scaling.....	58
Designation of machine type.....	5
Detergent.....	18
Detergent and rinse aid.....	17
Dimming display brightness.....	52
Dismantling.....	60
Dismantling and disposal.....	59
Disposal of packaging materials.....	59
Disposal of the old device.....	60
Dosing equipment.....	18
E	
EC/EU declaration of conformity.....	22
Eco mode.....	21
Electrical connection	
Earth wire system.....	25
Fixed connection.....	25
Local fuse protection.....	26
Local mains isolator.....	26
Other dangers.....	25
Possibility to switch.....	27
Power cable.....	25
Protective equipotential bonding.....	26
Voltage/frequency.....	25
Who may connect it?.....	25
With/without protective equipotential bonding.....	25
Energy saving	
Eco mode.....	21
Exhaust heat recovery.....	21
Heat retention.....	21
Wastewater heat recovery.....	21
Ergonomics	
Automatic hood system.....	19
F	
Forced drainage.....	22
Functional description.....	14
Fundamental safety and accident prevention regulations.....	12
G	
GiO-MODULE.....	19
Glass control panel.....	15, 30
H	
Hood.....	15
Hood handle.....	15
I	
i-menu.....	47
Indicator light.....	15, 17
Initiation functions.....	38
Intelli-start.....	19, 40
Intended use.....	11
L	
Liability and warranty.....	6
M	
Machine weight.....	22
Maintenance.....	54
Maintenance and cleaning.....	53
Maintenance table.....	55
Malfunctions.....	42
manual hood.....	42
Menu overview	

action menu.....	48	maintenance counter.....	48
i-menu	47	reverse osmosis (UO) filter insert	48
Messages	43	Reset the counter.....	48
N		Residual risks.....	9
Noise emissions.....	22	Restricted operation.....	43, 44, 45
Notes in the instructions	7	Rinse aid.....	18
Notes on the operating instructions	5	S	
O		Safety.....	7
Operation panel	15	Safety symbols in the instructions	8
Operation/use	30	Service codes	46
Options.....	19	Shutting down the dishwashing machine	46
rack detection.....	16	Spare parts	59
Thermal disinfection.....	19	Suction lances.....	18
Overview illustration.....	15	Switching off.....	46
exterior view.....	15	Symbol explanation.....	7
interior view	16	T	
P		Technical data.....	22
Perform a manual water change	52	Thermal disinfection.....	19, 20
Perform assembly.....	27	Thermolabel disinfection.....	20
Perform commissioning	29	Transport.....	27
Personalise machine	50	U	
Prerequisites for assembly	23	Unintended use.....	11
Pressure levels	19	V	
Private Label 2.0.....	50	Ventilate detergent supply	48
Product description	14	Ventilate rinse pipe	48
Programme		Ventilating the pipes	52
Configuration.....	34	W	
Programmes		Waiting time Private Label	51
HL 37		Wash arm.....	16
HM/HXL	35	Washing	
HM-PW/HXL-PW.....	36	emptying the washware	41
R		Extended cycle runtime	39, 40
Rack detection	19, 40	Preparation	31
Rack guide.....	16	putting in washware	33
Related documents.....	6	putting the machine into operation.....	33
Replace canister	32, 53	rack detection	16
Requirements for the fresh water connection.....	23	Rack detection	19, 40
Requirements for the installation area.....	23	Select wash programme	34
Requirements for the personnel	9	Start wash cycle	38
Requirements for the waste water connection	23	Touch operation.....	39
Requirements to the electrical connection.....	25	With wash key.....	38
Reset counter		Water change.....	48
demineralisation cartridge	48	What to do in the event of an emergency	14



The clean solution



MEIKO Maschinenbau GmbH & Co. KG

Englerstraße 3

77652 Offenburg

Germany

www.meiko-global.com

info@meiko-global.com

Design and construction subject to change without prior notice!